

USER'S GUIDE
Dynamic Measurement DC Source
HP Model 66312A
System DC Power Supply
HP Model 6612B

For Instruments with Serial Numbers:

HP 66312A: US36310101 and up

HP 6612B: US36340101 and up



**HEWLETT
PACKARD**

HP Part No. 5962-0872

Microfiche Part No. 5962-0873

Printed in USA: August 1996

CERTIFICATION

Hewlett-Packard Company certifies that this product met its published specifications at time of shipment from the factory. Hewlett-Packard further certifies that its calibration measurements are traceable to the United States National Bureau of Standards, to the extent allowed by the Bureau's calibration facility, and to the calibration facilities of other International Standards Organization members.

WARRANTY

This Hewlett-Packard hardware product is warranted against defects in material and workmanship for a period of three years from date of delivery. HP software and firmware products, which are designated by HP for use with a hardware product and when properly installed on that hardware product, are warranted not to fail to execute their programming instructions due to defects in material and workmanship for a period of 90 days from date of delivery. During the warranty period, HP Company will, at its option, either repair or replace products which prove to be defective. HP does not warrant that the operation of the software, firmware, or hardware shall be uninterrupted or error free.

For warranty service, with the exception of warranty options, this product must be returned to a service facility designated by HP. Customer shall prepay shipping charges (and shall pay all duty and taxes) for products returned to HP for warranty service. Except for products returned to Customer from another country, HP shall pay for return of products to Customer.

Warranty services outside the country of initial purchase are included in HP's product price only if Customer pays HP international prices (defined as destination local currency price, or U.S. or Geneva Export price).

If HP is unable, within a reasonable time, to repair or replace any product to condition as warranted, the Customer shall be entitled to a refund of the purchase price upon return of the product to HP.

LIMITATION OF WARRANTY

The foregoing warranty shall not apply to defects resulting from improper or inadequate maintenance by the Customer, Customer-supplied software or interfacing, unauthorized modification or misuse, operation outside of the environmental specifications for the product, or improper site preparation and maintenance. NO OTHER WARRANTY IS EXPRESSED OR IMPLIED. HP SPECIFICALLY DISCLAIMS THE IMPLIED WARRANTIES OF MERCHANTABILITY AND FITNESS FOR A PARTICULAR PURPOSE.

EXCLUSIVE REMEDIES

THE REMEDIES PROVIDED HEREIN ARE THE CUSTOMER'S SOLE AND EXCLUSIVE REMEDIES. HP SHALL NOT BE LIABLE FOR ANY DIRECT, INDIRECT, SPECIAL, INCIDENTAL, OR CONSEQUENTIAL DAMAGES, WHETHER BASED ON CONTRACT, TORT, OR ANY OTHER LEGAL THEORY.

ASSISTANCE

The above statements apply only to the standard product warranty. Warranty options, extended support contracts, product maintenance agreements and customer assistance agreements are also available. Contact your nearest Hewlett-Packard Sales and Service office for further information on HP's full line of Support Programs.

SAFETY SUMMARY

The following general safety precautions must be observed during all phases of operation of this instrument. Failure to comply with these precautions or with specific warnings elsewhere in this guide violates safety standards of design, manufacture, and intended use of the instrument. Hewlett-Packard Company assumes no liability for the user's failure to comply with these requirements.

GENERAL

This product is a Safety Class 1 instrument (provided with a protective earth terminal). It is intended for use in an installation category II, pollution degree 2 environment. The protective features of this product may be impaired if it is used in a manner not specified in the operation instructions.

BEFORE APPLYING POWER

Verify that the product is set to match the available line voltage, the correct fuse is installed, and all safety precautions are taken. Note the instrument's external markings described under "Safety Symbols".

GROUND THE INSTRUMENT

To minimize shock hazard, the instrument chassis and cover must be connected to an electrical ground. The instrument must be connected to the ac power mains through a grounded power cable, with the ground wire firmly connected to an electrical ground (safety ground) at the power outlet. Any interruption of the protective (grounding) conductor or disconnection of the protective earth terminal will cause a potential shock hazard that could result in personal injury.

ATTENTION: Un circuit de terre continu est essentiel en vue du fonctionnement sécuritaire de l'appareil. Ne jamais mettre l'appareil en marche lorsque le conducteur de mise à la terre est débranché.

FUSES

Only fuses with the required rated current, voltage, and specified type (normal blow, time delay, etc.) should be used. Do not use repaired fuses or short-circuited fuseholders. To do so could cause a shock or fire hazard.

DO NOT OPERATE IN AN EXPLOSIVE ATMOSPHERE

Do not operate the instrument in the presence of flammable gases or fumes.

DO NOT REMOVE THE INSTRUMENT COVER

Operating personnel must not remove instrument covers. Component replacement and internal adjustments must be made only by qualified service personnel.

SAFETY SYMBOLS



Refer to operating manual.



Earth ground terminal.



Hazardous voltages.

WARNING

This sign denotes a hazard. It calls attention to a procedure, practice, or the like which, if not correctly performed or adhered to, could result in personal injury. Do not proceed beyond a WARNING sign until the indicated conditions are fully understood and met.

CAUTION

This sign denotes a hazard. It calls attention to a procedure, practice, or the like which, if not correctly performed or adhered to, could result in damage to or destruction of part or all of the instrument. Do not proceed beyond a CAUTION sign until the indicated conditions are fully understood and met.

Instruments that appear damaged or defective should be made inoperative and secured against unintended operation until they can be repaired by qualified service personnel.

ACOUSTIC NOISE INFORMATION

Herstellerbescheinigung

Diese Information steht im Zusammenhang mit den Anforderungen der Maschinenlärminformationsverordnung vom 18 Januar 1991.

* Schalldruckpegel $L_p < 70$ dB(A) * Am Arbeitsplatz * Normaler Betrieb * Nach EN 27779 (Typprüfung)

Manufacturer's Declaration

This statement is provided to comply with the requirements of the German Sound Emission Directive, from 18 January 1991. This product has a sound pressure emission (at the operator position) < 70 dB.

* Sound Pressure $L_p < 70$ dB(A) * At Operator Position * Normal Operation

* According to EN 27779 (Type Test).

Printing History

The edition and current revision of this manual are indicated below. Reprints of this manual containing minor corrections and updates may have the same printing date. Revised editions are identified by a new printing date. A revised edition incorporates all new or corrected material since the previous printing date.

Changes to the manual occurring between revisions are covered by change sheets shipped with the manual. In some cases, the manual change applies only to specific instruments. Instructions provided on the change sheet will indicate if a particular change applies only to certain instruments.

This document contains proprietary information protected by copyright. All rights are reserved. No part of this document may be photocopied, reproduced, or translated into another language without the prior consent of Hewlett-Packard Company. The information contained in this document is subject to change without notice.

Contents

1. Quick Reference	
HP 66312A Dynamic Measurement DC Source and HP 6612B System DC Power	
Supply	1-1
The Front Panel - At a Glance	1-2
Front Panel Number Entry	1-3
Front Panel Annunciators	1-4
Immediate Action Keys	1-4
Front Panel Menus - At a Glance	1-5
Programming Commands - At a Glance	1-6
The Rear Panel - At a Glance	1-7
2. General Information	
Document Orientation	2-1
Safety Considerations	2-2
Instrument Identification	2-2
Options and Accessories	2-2
Description	2-3
Capabilities	2-3
Front Panel Controls	2-3
Remote Programming	2-3
Output Characteristic	2-4
3. Installation	
Inspection	3-1
Damage	3-1
Packaging Material	3-1
Items Supplied	3-1
Cleaning	3-1
Location	3-2
Bench Operation	3-2
Rack Mounting	3-2
⚠ Input Connections	3-3
Connect the Power Cord	3-3
⚠ Output Connections	3-3
Wire Considerations	3-3
Current Ratings	3-3
Voltage Drops	3-4
Multiple Load Connections	3-4
Remote Sense Connections	3-5
Sense Leads	3-5
Stability	3-6

OVP Considerations	3-6
INH/FLT Connections	3-6
Controller Connections	3-8
HP-IB Interface	3-8
RS-232 Interface	3-8
4. Turn-On Checkout	
Introduction	4-1
Using the Keypad	4-1
Checkout Procedure	4-2
In Case of Trouble	4-4
Error Messages	4-4
Selftest Errors	4-4
Runtime Error Messages	4-4
Line Fuse	4-4
5. Front Panel Operation	
Introduction	5-1
Front Panel Description	5-1
System Keys	5-3
Function Keys	5-4
Immediate Action Keys	5-4
Scrolling Keys	5-4
Metering Keys	5-5
Output Control Keys	5-6
Entry Keys	5-7
Examples of Front Panel Programming	5-8
1 - Setting the Output Voltage and Current	5-8
2 - Querying and Clearing Output Protection	5-9
3 - Making Front Panel Measurements	5-9
4 - Programming the Digital Output Port	5-11
5 - Setting the HP-IB Address and RS-232 Parameters	5-12
6 - Saving and Recalling Operating States	5-12
A. Specifications	
Specifications	A-1
Supplemental Characteristics	A-2
B. Verification & Calibration	
Introduction	B-1
Equipment Required	B-1
Test Setup	B-1
Performing the Verification Tests	B-2
Turn-On Checkout	B-3
Voltage Programming and Measurement Accuracy	B-3
Current Programming and Measurement Accuracy	B-3
Performing the Calibration Procedure	B-6
Front Panel Calibration Menu	B-6
Front Panel Calibration	B-7
Enable Calibration Mode	B-7
Voltage Programming and Measurement Calibration	B-7

Overvoltage Protection Calibration	B-7
Current Programming and High-Range Measurement Calibration	B-8
Low-Range Current Measurement Calibration	B-8
AC Current Measurement Calibration (HP 66312A only)	B-9
Saving the Calibration Constants	B-10
Calibration Error Messages	B-10
Changing the Calibration Password	B-10
Calibration Over the HP-IB	B-11
C. Error Messages	
Error Number List	C-1
D. Line Voltage Conversion	
Open the Unit	D-1
Configure the Power Transformer	D-1
Install the Correct Line Fuse	D-2
Close the Unit	D-1
Index	



Quick Reference

HP 66312A Dynamic Measurement DC Source and HP 6612B System DC Power Supply

The HP 66312A is a 40 Watt, high performance dc power supply that provides dynamic measurement and analysis of voltage and current waveforms. It is designed to simplify the testing of digital cellular and mobile phones. For example, data acquired using its dynamic measurement capability can be used in determining the battery operating time of digital wireless communications products.

The HP 6612B is a 40 Watt, high performance dc power supply with output current measurement capability in the microampere range. It is well suited for testing portable battery-powered products.

Additionally, the combination of bench-top and system features in these dc sources provide versatile solutions for your design and test requirements.

Convenient bench-top features

- ◆ Up to 40 Watts output power
- ◆ Easy to use knob for voltage and current settings
- ◆ Highly visible vacuum-fluorescent front panel display
- ◆ Excellent load and line regulation; low ripple and noise
- ◆ Measurement capability down to microampere levels
- ◆ Triggered acquisition of digitized output current and voltage waveforms (HP 66312A only)
- ◆ Current sinking up to 1 A maximum
- ◆ Instrument state storage
- ◆ Portable case

Flexible system features

- ◆ HP-IB (IEE-488) and RS-232 interfaces are standard
- ◆ SCPI (Standard Commands for Programmable Instruments) compatibility
- ◆ I/O setup easily done from the front panel



The Front Panel - At a Glance

① 14-character display shows output measurements and programmed values.

② Annunciators indicate operating modes and status conditions.

③ Rotary control sets voltage, current, and menu parameters.

④ Front panel output connectors.

Use  and  to set the resolution; then adjust the value with the knob.

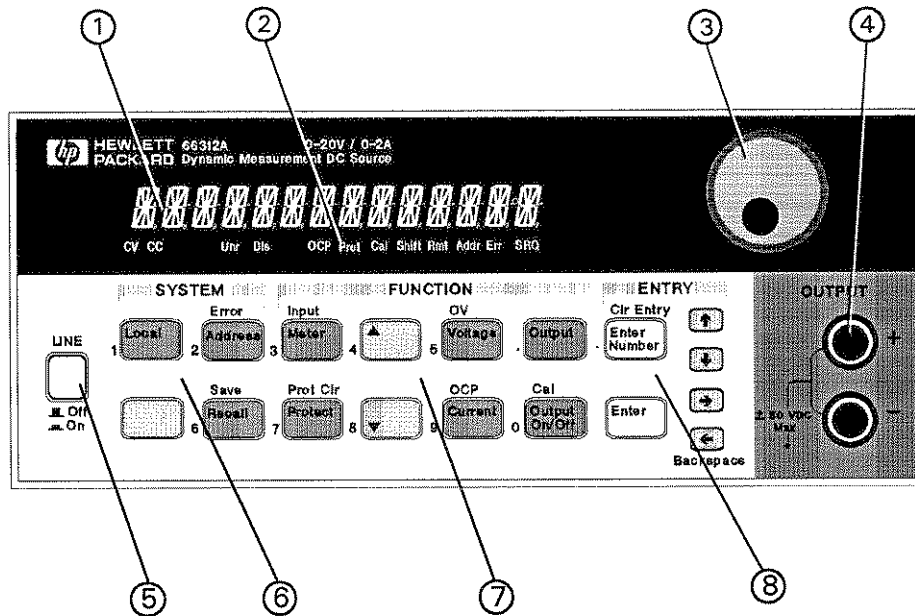



⑤ Turns the dc source on and off.





⑥ System keys:

- ◆ return to Local mode
- ◆ set the HP-IB address
- ◆ set the RS-232 interface
- ◆ display SCPI error codes
- ◆ save and recall instrument states.

⑦ Function keys:

- ◆ enable/disable output
- ◆ select metering functions
- ◆ program voltage and current
- ◆ set and clear protection functions
- ◆  and  scroll through the front panel menu commands.

⑧ Entry keys:

- ◆ enter values
- ◆ increment or decrement values
- ◆  and  select front panel menu parameters.
- ◆  and  select a digit in the numeric entry field.

Front Panel Number Entry

Enter numbers from the front panel using one of the following methods:

Use the arrow keys and knob to change voltage or current settings

NOTE The output must be ON to see the displayed values change in Meter mode.

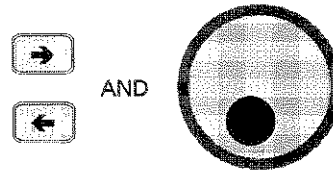

Use the Function keys and knob to change the displayed settings

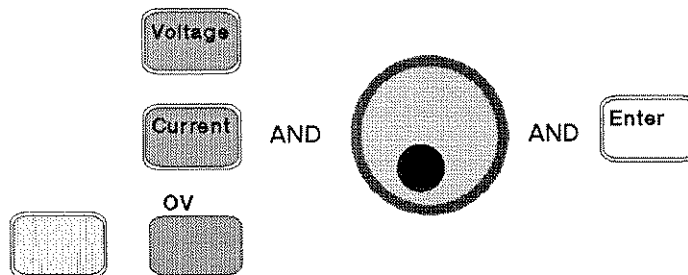

Use the Arrow keys to edit individual digits in the displayed setting

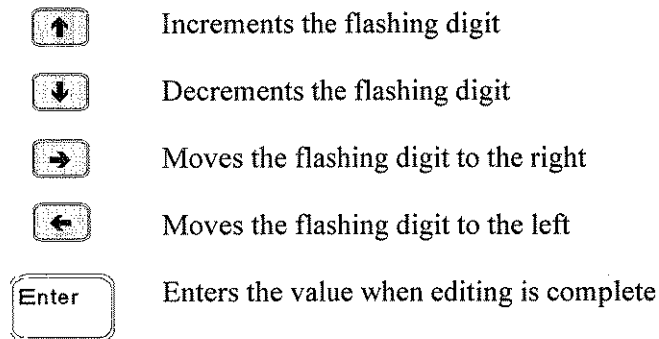

Use the Function keys and Entry keys to enter a new value

NOTE If you make a mistake, use the Backspace key to delete the number, or press the Meter key to return to meter mode.

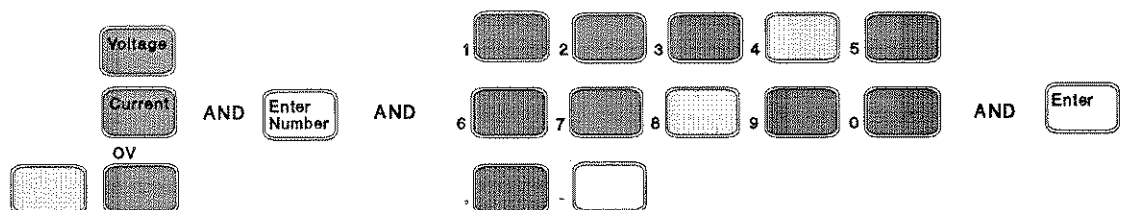







Front Panel Annunciators



CV CC Unr Dis OCP Prot Cal Shift Rmt Addr Err SRQ

CV	The output is operating in constant voltage mode.
CC	The output is operating in constant current mode.
Unr	The output is unregulated.
Dis	The output is OFF. Press the Output On/Off key to turn the output on.
OCP	The over-current protection state is ON. Press the OCP key to turn over-current protection off.
Prot	Indicates that the output has been disabled by one of the protection features. Press the Prot Clear key to clear the protection condition.
Cal	Calibration mode is ON. Scroll to the Cal Off command and press the Enter key to exit the calibration mode.
Shift	The Shift key has been pressed.
Rmt	The selected Remote programming interface (either HP-IB or RS-232) is active. Press the Local key to return the unit to front panel control.
Addr	The interface is addressed to talk or listen.
Err	There is an error in the SCPI error queue. Press the Error key to view the error code.
SRQ	The interface is requesting service.

Immediate Action Keys

	A toggle switch that turns the output of the dc source on or off.
	Activates front panel control when the unit is in remote mode (unless a Lockout command is in effect).
 	Resets the protection circuit and allows the unit to return to its last programmed state.
 	A toggle switch that enables or disables overcurrent protection.

Front Panel Menus - At a Glance

Address	ADDRESS 7	Sets the HP-IB Address
▼	INTF HPIB	Selects an interface (HPIB or RS232)
▼	BAUDRATE 300	Selects baud rate (300, 600, 1200, 2400, 4800, 9600)
▼	PARITY NONE	Selects message parity (NONE, EVEN, ODD, MARK, SPACE)
▼	FLOW NONE	Selects flow control (XON-XOFF, NONE)
▼	LANG SCPI	Selects language (SCPI or COMP)

Recall	*RCL 0	Recalls instrument state
---------------	--------	--------------------------

Shift		
Save	*SAV 0	Saves present instrument state

Shift		
Error	ERROR 0	Displays errors in SCPI error queue

Meter	12.000V 0.204A	Measures output voltage and current
▼	12.500V MAX	Measures peak output voltage ¹
▼	1.000V MIN	Measures minimum output voltage ¹
▼	12.330V HIGH	Measures the high level of a voltage pulse waveform ¹
▼	0.080V LOW	Measures the low level of a voltage pulse waveform ¹
▼	12.000V RMS	Measures rms voltage ¹
▼	0.350A MAX	Measures peak output current ¹
▼	0.050A MIN	Measures minimum output current ¹
▼	0.400A HIGH	Measures the high level of a current pulse waveform ¹
▼	0.012A LOW	Measures the low level of a current pulse waveform ¹
▼	0.210A RMS	Measures rms current ¹

Voltage	VOLT 20.000	Sets the output voltage
----------------	-------------	-------------------------

Current	CURR 2.000	Sets the output current
----------------	------------	-------------------------

Protect	OC - - - - -	Protection status (example shows overcurrent tripped)
----------------	--------------	---



Output	*RST	Places the dc source in the factory-default state
▼	PON:STATE RST	Select the power-on state command (RST or RCL0)
▼	PROT:DLY 0.08	Sets the output protection delay in seconds
▼	RI LATCHING	Sets the remote inhibit mode (LATCHING, LIVE, or OFF)
▼	DFI OFF	Sets the discrete fault indicator state (ON or OFF)
▼	DFI:SOUR OFF	Selects the DFI source (QUES, OPER, ESB, RQS, or OFF)
▼	PORT RIDFI	Sets the output port functions (RIDFI or DIGIO)
▼	DIGIO 7	Sets and reads the I/O port value (0 through 7)

Shift		
OV	VOLT:PROT 22	Sets overvoltage protection level

Shift		
Input	CURR:RANG HIGH	Sets current range (HIGH, LOW, or AUTO)
▼	CURR:DET ACDC	Sets current measurement detector (ACDC or DC) ¹

Shift		
Cal	CAL ON	Accesses calibration menu (See User's Guide).

¹Not available on HP Model 6612B

Use  and  to select menu parameters

Use  to exit any menu and return to meter mode

Programming Commands - At a Glance

NOTE Most [optional] commands have been omitted for clarity. Refer to the Programming Guide for a complete description of all programming commands.

ABORt

CALibrate

:CURRent [:POSitive]
:MEASure :LOWRange
:AC¹

:DATA <n>
:LEVel P1 | P2 | P3 | P4
:PASSword <n>
:SAVE
:STATe <bool> [, <n>]
:VOLTage :PROTection

DISPlay

<bool>
:MODE NORMal | TEXT
:TEXT <display_string>

INITiate

:SEquence[1|2]
:NAME TRANsient | ACQuire¹
:CONTinuous :SEquence[1], <bool>
:NAME TRANsient, <bool>

MEASure | FETCh

:ARRay :CURRent?¹
:VOLTage?¹
[:CURRent][:DC]?²
:ACDC?¹
:HIGH?¹
:LOW?¹
:MAX?¹
:MIN?¹
:VOLTage [:DC]?²
:ACDC?¹
:HIGH?¹
:LOW?¹
:MAX?¹
:MIN?¹

OUTPut

<bool>
:DFI <bool>
:SOURce QUES | OPER | ESB | RQS | OFF
:PON :STATe RST | RCL0
:PROTection :CLEar
:DElay <n>
:RI :MODE LATCHing | LIVE | OFF

SENSe

:CURRent :RANGe <n>
:DETEctor ACDC | DC¹
:FUNCTion "VOLT" | "CURR"¹
:SWEep :OFFSet :POINts <n>¹
:POINts <n>
:TINTerval <n>

[SOURce:] CURRent <n>

:TRIGgered <n>
:PROTection :STATe <bool>

DIGital :DATA <n>
:FUNCTion RIDF | DIG

VOLTage <n>
:TRIGgered <n>
:PROTection <n>

STATus

:PRESet
:OPERation [:EVENT]?
:CONDition?
:ENABle <n>
:NTRansition <n>
:PTRansition <n>
:QUESTionable [:EVENT]?
:CONDition?
:ENABle <n>
:NTRansition <n>
:PTRansition <n>

SYSTem

:ERRor?
:LANGUage SCPI | COMPatibility
:VERSion?
:LOCal
:REMote
:RWLock

TRIGger

:SEquence 2 | :ACQuire [:IMMediate]¹
:COUNT :CURRent <n>¹
:VOLTage <n>¹
:HYSTeresis:CURRent <n>¹
:VOLTage <n>¹
:LEVel :CURRent <n>¹
:VOLTage <n>¹
:SLOPe :CURRent POS | NEG | EITH¹
:VOLTage POS | NEG | EITH¹
:SOURce BUS | INTernal¹
[:SEquence1 | :TRANsient][:IMMediate]
:SOURce BUS
:SEquence1 :DEFine TRANsient
:SEquence2 :DEFine ACQuire¹

¹Not available on HP Model 6612B

²Fetch commands not available on HP Model 6612B

The Rear Panel - At a Glance

① HP-IB (IEEE-488) interface connector

② RS-232 interface connector

③ INH/FLT (remote INHibit / internal FauLT) connector. Connector plug is removable.

④ Output and Remote sense connector. Connector plug is removable.

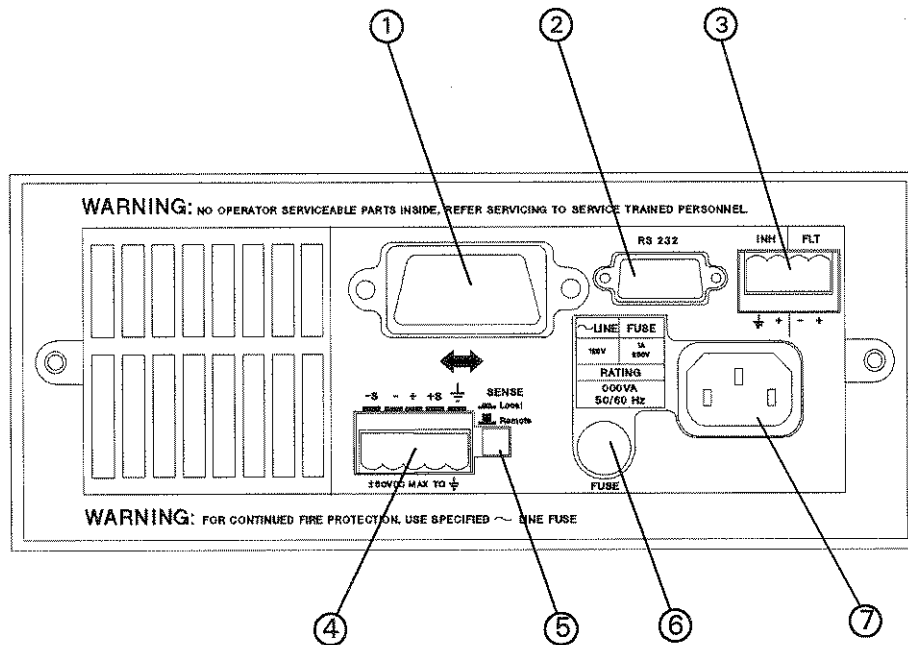

⑤ Remote or Local sense switch

⑥ Fuse holder

⑦ Power cord connector (IEC 320)

Use the front panel Address menu to

- ◆ Select the HP-IB or RS-232 interface (see chapter 4 in User's Guide)
- ◆ Select the HP-IB bus address (see chapter 4 in User's Guide)
- ◆ Configure the RS-232 interface (see chapter 4 in User's Guide)



General Information

Document Orientation

This manual describes the operation of the HP Model 66312A Dynamic Measurement DC Source and the HP Model 6612B System DC Power Supply. Unless otherwise noted, both units will be referred to by the description “dc source” throughout this manual. The following documents are shipped with your dc source:

- a User’s Guide (p/n 5962-0872), containing detailed installation, checkout, and front panel information
- a Programming Guide (p/n 5962-8108), containing detailed HP-IB programming information

You will find information on the following tasks in these guides. Refer to the table of contents of each guide for a complete list of the topics.

Topic	Location
Accessories and Options	Chapter 2 - this guide
Calibrating the dc source	Appendix B - this guide
Front panel keys	Chapter 5 - this guide
Front panel programming examples	Chapter 5 - this guide
Line voltage connections	Chapter 3 - this guide
Line voltage ratings	Appendix A - this guide
Operator replaceable parts	Chapter 2 - this guide
Operator troubleshooting	Chapter 4 - this guide
Operating characteristics	Appendix A - this guide
Performance specifications	Appendix A - this guide
Quick operating checkout	Chapter 4 - this guide
Rack mounting	Chapter 3 - this guide
RS-232 operation	Chapter 3 - this guide
SCPI programming examples	Chapter 3 - Programming Guide
SCPI programming commands	Chapter 4 - Programming Guide
Turn-on/checkout	Chapter 4 - this guide
Wiring - discrete fault indicator (DFI)	Chapter 3 - this guide
- HP-IB controller	Chapter 3 - this guide
- load or loads	Chapter 3 - this guide
- voltage sensing (local and remote)	Chapter 3 - this guide
- remote inhibit (RI)	Chapter 3 - this guide

Safety Considerations

This dc source is a Safety Class 1 instrument, which means it has a protective earth terminal. That terminal must be connected to earth ground through a power source equipped with a ground receptacle. Refer to the Safety Summary page at the beginning of this guide for general safety information. Before installation or operation, check the dc source and review this guide for safety warnings and instructions. Safety warnings for specific procedures are located at appropriate places in the guide.

Options and Accessories

Table 2-1. Options

Option	Description
100	87–106 Vac, 47–63 Hz
220	191–233 Vac, 47–63 Hz
230	207–253 Vac, 47–63 Hz
1CM ¹	Rack mount kit for one unit (HP p/n 5062-3972)
ACX ¹	Rack mount kit for 2 side-by-side units. Consists of: Lock-link kit (HP p/n 5061-9694) and Flange kit (HP p/n 5062-3974)
910	Service manual with extra operating manuals

¹ Support rails are required when rack mounting units. Use E3663A support rails for HP rack cabinets, and E3664A for non-HP rack cabinets.

Table 2-2. Accessories

Item	HP Part Number
HP-IB cables	
1.0 meter (3.3 ft)	10833A
2.0 meters (6.6 ft)	10833B
4.0 meters (13.2 ft)	10833C
0.5 meters (1.6 ft)	10833D
RS-232 cable	34398A
(9-pin F to 9-pin F, 2.5 meter, null modem/printer cable with one 9-pin M to 25-pin F adapter)	
RS-232 adapter kit (contains 4 adapters)	34399A
9-pin M to 25-pin M for pc or printer	
9-pin M to 25-pin M for pc or printer	
9-pin M to 25-pin M for modem	
9-pin M to 9-pin M for modem	

Description

Both the HP 66312A Dynamic Measurement DC Source and the HP 6612B System DC Power Supply combine two instruments in one unit. It includes a dc source, which produces dc output with programmable voltage and current amplitude, and a highly accurate voltage and current meter, with the capability to measure very low-level currents. Additionally, the HP 66312A Dynamic Measurement DC Source has the ability to measure and characterize output voltage and current of pulse or ac waveforms.

Capabilities

- Output Voltage and Current control with 12-bit programming resolution
- Extensive measurement capability:
 - dc voltage and current.
 - rms and peak voltage and current (HP 66312A only).
 - 16-bit measurement resolution (low range accurate down to 2 microamperes).
 - Triggered acquisition of digitized current and voltage waveforms (HP 66312A only).
- Front panel control with 14-character vacuum fluorescent display, keypad, and rotary control for voltage and current settings.
- Built-in HP-IB and RS-232 interface programming with SCPI command language.
- Non-volatile state storage and recall.
- Over-voltage, over-current, over-temperature, and RI/DFI protection features.
- Extensive selftest, status reporting, and software calibration.

Front Panel Controls

The front panel has both rotary (RPG) and keypad controls for setting the output voltage and current. The panel display provides digital readouts of a number of output measurements. Annunciators display the operating status of the dc source. System keys let you perform system functions such as setting the HP-IB address and recalling operating states. Front panel Function keys access the dc source function menus. Front panel Entry keys let you select and enter parameter values.

Note Refer to chapter 5 for a complete description of the front panel controls.

Remote Programming

The dc source may be remotely programmed via the HP-IB bus and/or from an RS-232 serial port. HP-IB programming is with SCPI (Standard Commands for Programmable Instruments) commands that make the dc source programs compatible with those of other HP-IB instruments. Compatibility commands are also included to make the dc source compatible with the HP 6632A, 6633A, and 6634A Series dc power supplies. Dc source status registers allow remote monitoring of a wide variety of dc source operating conditions.

Note Refer to the Programming Guide supplied with your dc source for further information about remotely programming the dc source.

Output Characteristic

The dc source's output characteristic is shown in the following figure. The output of the dc source may be adjusted to any value within the boundaries shown.

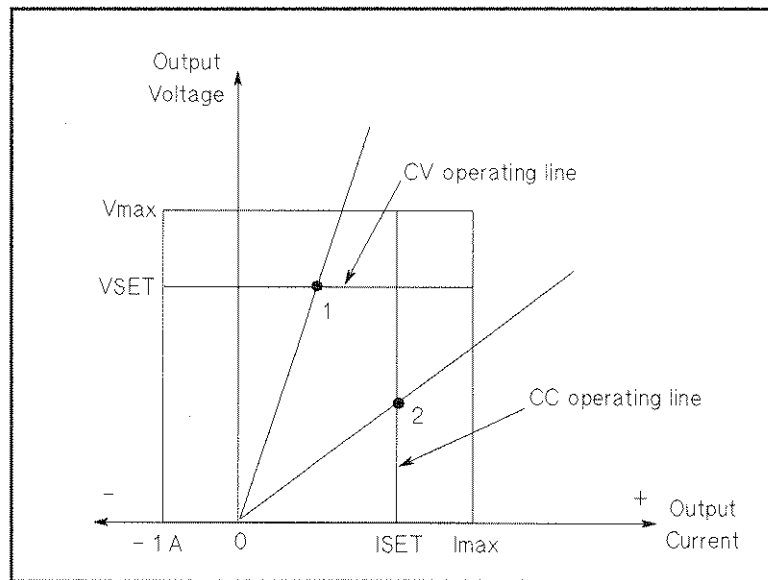

Figure 2-1. Dc Source Output Characteristic

The dc source can operate in either constant voltage (CV) or constant current (CC) over the rated output voltage and current. Figure 2-1 shows a single range –two quadrant capability. This means that the dc source is capable of sourcing as well as sinking current over the output voltage range from zero volts to the rated maximum. The negative current sinking capability of the dc source is not programmable, and is fixed at a maximum of 1 A.

The operating point of the unit is determined by the voltage setting, current setting, and the load resistance. In figure 2-1, operating point 1 is defined by the load line traversing the positive operating quadrant in the constant voltage region. Operating point 2 is defined by the load line traversing the positive operating quadrant in the constant current region.

Note

If you attempt to operate the dc source beyond its output ratings, the output of the unit will become unregulated. This is indicated by the UNR annunciator on the front panel. The output may also become unregulated if the ac input voltage drops below the minimum rating specified in Appendix A.

Appendix A documents the dc source's specifications and supplemental characteristics.

Installation

Inspection

Damage

When you receive your dc source, inspect it for any obvious damage that may have occurred during shipment. If there is damage, notify the shipping carrier and the nearest HP Sales and Support Office immediately. The list of HP Sales and Support Offices is at the back of this guide. Warranty information is printed in the front of this guide.

Packaging Material

Until you have checked out the dc source, save the shipping carton and packing materials in case the unit has to be returned. If you return the dc source for service, attach a tag identifying the model number and the owner. Also include a brief description of the problem.

Items Supplied

The following user-replaceable items are included with your dc source. Some of these items are installed in the unit.

Table 3-1. Items Supplied

Item	Part Number	Description
Power Cord	contact nearest HP Sales and Support Office	A power cord appropriate for your location.
Digital connector	1252-1488	A 4-terminal digital plug that connects to the back of the unit.
Output connector	0360-2604	A 5-terminal plug that connects to the back of the unit.
Line Fuse	2110-0002 2110-0012	2 A for 100/120 Vac operation 1 A for 220/230 Vac operation
Feet	5041-8801	feet for bench mounting
User's Guide	5962-0872	Contains installation, checkout, and front panel information.
Programming Guide	5962-8108	Contains detailed HP-IB programming information.

Cleaning

Use a dry cloth or one slightly dampened with water to clean the external case parts. Do not attempt to clean internally.

Warning To prevent electric shock, unplug the unit before cleaning.

Location

The outline diagram in figure 3-1 gives the dimensions of your dc source. The dc source must be installed in a location that allows sufficient space at the sides and back of the unit for adequate air circulation (see Bench Operation).

Bench Operation

A fan cools the dc source by drawing air in through the sides and exhausting it out the back. Minimum clearances for bench operation are 1 inch (25 mm) along the sides. Do not block the fan exhaust at the rear of the unit.

Rack Mounting

The dc source can be mounted in a standard 19-inch rack panel or cabinet. The following rack mount and slide kits are available to rack-mount units. Installation instructions are included with each kit.

Table 3-2. Rack Mounting Accessories

Item	HP Part Number
Adapter kit for a single unit (same as option 1CM)	5062-3972
Lock Link kit and Flange kit for two side-by-side units (option AXS)	5062-3974 and 5061-9694
Support rails required for HP rack cabinets,	E3663
Support rails required for non-HP rack cabinets.	E3664A

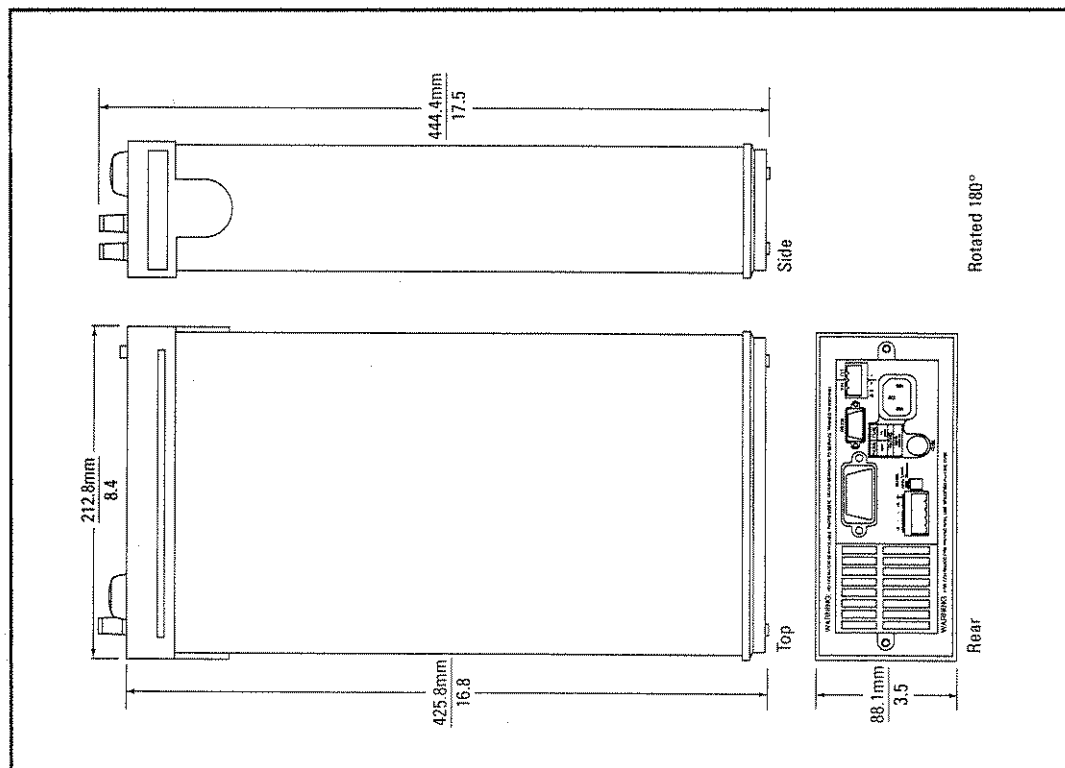

Figure 3-1. Outline Diagram

 **Input Connections****Connect the Power Cord**

1. Unscrew the line fuse cap from the rear panel and verify that the fuse rating matches what is specified on the **FUSES** label on the rear panel. Reinstall the fuse. (See table 3-1 for fuse part numbers.)
2. Connect the power cord to the IEC 320 connector on the rear of the unit. If the wrong power cord was shipped with your unit, contact your nearest HP Sales and Support Office (refer to the list at the back of this guide) to obtain the correct cord.

 **Output Connections**

The **output connector** has a termination for the + and – output, the + and – sense terminals, and an earth ground terminal. The 5-pin connector is removable and accepts wires sizes from AWG 22 to AWG 12.

Disconnect the mating plug from the unit by pulling it straight back.

Front panel binding posts are available to connect load wires for bench operation. The front panel binding posts are paralleled with the rear panel + and – connections. *Before using the front panel binding posts, make sure that the sense switch on the back of the unit is set to Local.*

Wire Considerations

To minimize the possibility of instability on the output,

- keep load leads as short as possible
- bundle or twist the leads tightly together to minimize inductance

Current Ratings

Fire Hazard To satisfy safety requirements, load wires must be large enough not to overheat when carrying the maximum short-circuit current of the dc source. If there is more than one load, then any pair of load wires must be capable of safely carrying the full-rated current of the dc source.

The following table lists the characteristics of AWG (American Wire Gage) copper wire.

Table 3-3. Ampacity and Resistance of Stranded Copper Conductors

AWG No.	*Ampacity	**Resistance (Ω /m Ω /ft)	
20	8.33	0.0345	0.01054
18	15.4	0.0217	0.00663
16	19.4	0.0137	0.00417
14	31.2	0.0086	0.00262
12	40	0.0054	0.00165
*In free air		**At 20 °C	

Voltage Drops

The load wires must also be large enough to avoid excessive voltage drops due to the impedance of the wires. In general, if the wires are heavy enough to carry the maximum short circuit current without overheating, excessive voltage drops will not be a problem. The voltage drops across the load wires should be limited to less than two volts. Refer to Table 3-2 to calculate the voltage drop for some commonly used AWG copper wire.

Multiple Load Connections

When the unit is in local sensing mode and you are connecting multiple loads to the output, connect each load to the output terminals using separate load leads. This minimizes mutual coupling effects and takes full advantage of the dc source's low output impedance. Each pair of wires should be as short as possible and twisted or bundled to reduce lead inductance and noise pickup.

If cabling considerations require the use of distribution terminals that are located remotely from the dc source, connect the dc source output terminals to the remote distribution terminals by a pair of twisted or bundled wires. Connect each load to the distribution terminals separately. Remote voltage sensing is recommended under these circumstances. Sense either at the remote distribution terminals, or if one load is more sensitive than the others, sense directly at the critical load.

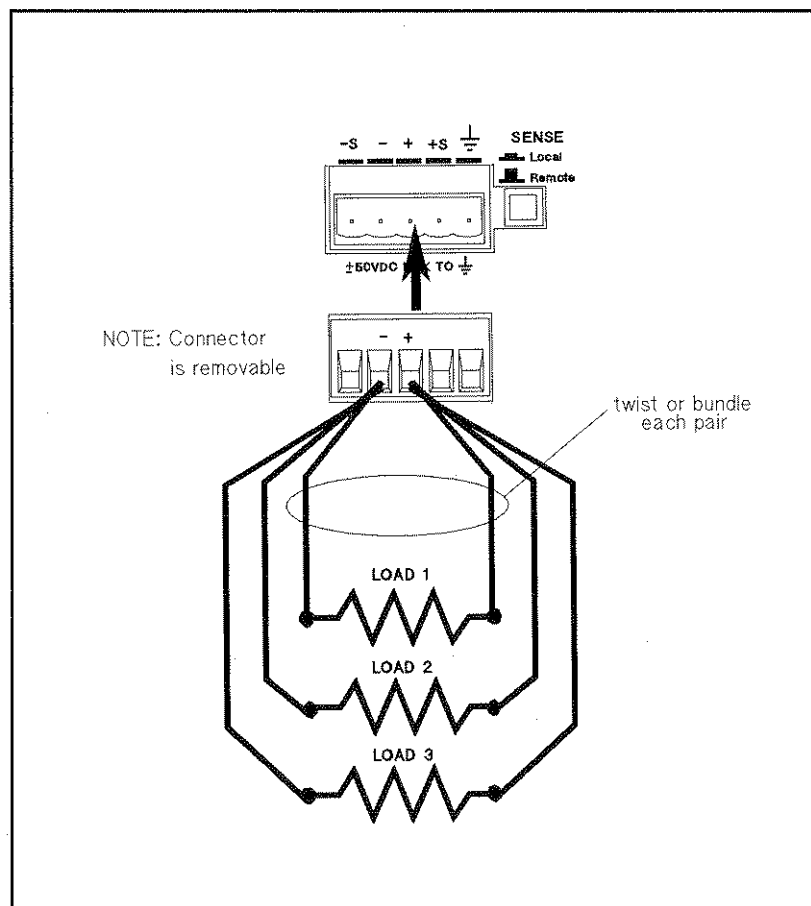

Figure 3-2. Multiple Load Connections

Remote Sense Connections

Under normal operation, the dc source senses the output voltage at the output terminals on the back of the unit. External sense terminals are available on the back of the unit that allow the output voltages to be sensed at the load, which compensates for impedance losses in the load wiring.

The output connector accepts wires sizes from AWG 22 to AWG 12. Disconnect the mating plug to make your wiring connections. When the sense wire connections are complete, set the Remote/Local switch on the back of the unit to Remote (switch is out).

Sense Leads

The sense leads are part of the dc source's feedback path and must be kept at a low resistance (less than several ohms) in order to maintain optimal performance. Connect the sense leads carefully so that they do not become open-circuited. If the sense leads are left unconnected or become open during operation, the dc source will regulate at the output terminals, resulting in a 3% to 5% increase in output over the programmed value. Shorting the sense leads trips the OVP circuit.

Note It is good engineering practice to twist and shield all signal wires to and from the sense connectors. Connect the shield at the dc source end only. Do not use the shield as one of the sensing conductors.

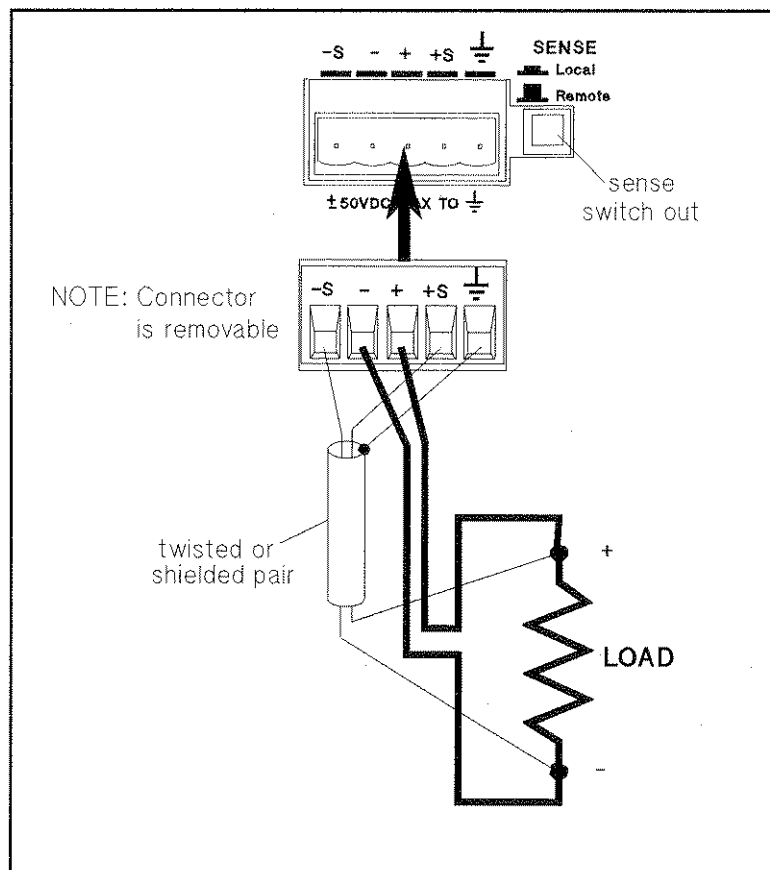

Figure 3-3. Remote Sense Connections

The overvoltage protection circuit senses voltage near the output terminals, not at the load. Therefore the signal sensed by the OVP circuit can be significantly higher than the actual voltage at the load. When using remote sensing, you must program the OVP trip voltage high enough to compensate for the voltage drop between the output terminals and the load. Also, if the sum of the programmed voltage and the load-lead drop exceeds the dc source's maximum voltage rating, this may also trip the OV protection circuit.

Stability

When the unit is configured for remote sensing, it is possible for the impedance of the load wires and the capacitance of the load to form a filter, which becomes part of the unit's feedback loop. This can degrade the unit's stability and result in poor transient response performance. In extreme cases it may also cause oscillations. The wiring guidelines previously discussed under "Wire Considerations" will eliminate most stability problems associated with load lead inductance. If additional measures are required:

- keep the load capacitance as small as possible
- use larger diameter load wires to reduce resistance

OVP Considerations

The dc source's OVP circuit contains a crowbar SCR, which effectively shorts the output of the dc source whenever the OVP trips. If an external voltage source such as a battery is connected across the output and the OVP is inadvertently triggered, the SCR will continuously sink a large current from the battery, possibly damaging the dc source.

To avoid this, program the OVP setting to its maximum value to prevent it from inadvertently tripping. Additionally, an internal fuse is connected in series with the SCR. This fuse will open to prevent large currents from damaging the SCR. If this internal fuse has opened, The FS status annunciator will be set. Refer to the Service Manual for instructions about replacing this fuse.

In addition, the OVP circuit's SCR crowbar has been designed to discharge capacitances up to a specific limit. This limit is 35,000 μ F.

If your load capacitance approaches this limit, it is recommended that you do not intentionally trip the OVP and discharge the capacitance through the SCR as part of your normal testing procedure, as this may lead to long-term failure of some components.

INH/FLT Connections

This rear panel connector, has a fault output port and an inhibit input port. The fault (FLT) output is also referred to as the DFI (discrete fault indicator) signal in the front panel and SCPI commands. The inhibit (INH) input is also referred to as the RI (remote inhibit) signal in the front panel and SCPI commands.

The connector can also be configured as a digital I/O port. Information on programming the digital connector is found in chapter 5. The electrical characteristics of the digital connector are described in appendix A.

The connector accepts wires sizes from AWG 22 to AWG 12. Disconnect the mating plug to make your wire connections.

Note It is good engineering practice to twist and shield all signal wires to and from the digital connectors

Figure 3-4 shows how you can connect the FLT/INH circuits of the dc source.

In **example A**, the INH input connects to a switch that shorts pin + to pin \perp whenever it is necessary to disable output of the unit. This activates the remote inhibit (RI) circuit, which turns off the dc output. The front panel **Prot** annunciator comes on and the RI bit is set in the Questionable Status Event register. To re-enable the unit, first open the connection between pins + and \perp and then clear the protection circuit. This can be done either from the front panel or over the HP-IB/RS-232.

In **example B**, the FLT output of one unit is connected to the INH input of another unit. A fault condition in one of the units will disable all of them without intervention either by the controller or external circuitry. The controller can be made aware of the fault via a service request (SRQ) generated by the Questionable Status summary bit.

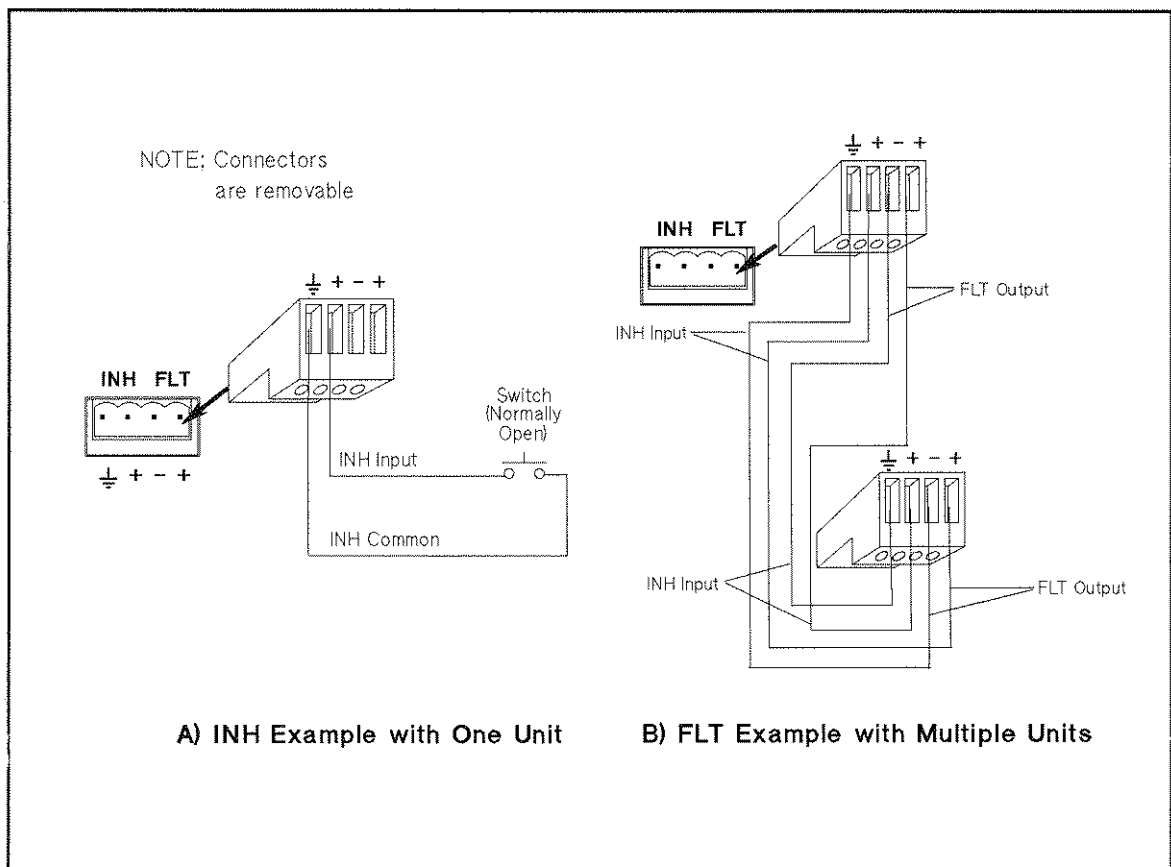

Figure 3-4. FLT/INH Examples

Controller Connections

The dc source connects to a controller either through an HP-IB or an RS-232 connector.

HP-IB Interface

Each dc source has its own HP-IB bus address, which can be set using the front panel **Address** key as described in chapter 5. HP-IB address data is stored in non-volatile memory. The dc source is shipped with its HP-IB address set to 5.

Dc sources may be connected to the HP-IB interface in series configuration, star configuration, or a combination of the two provided the following rules are observed:

- The total number of devices including the controller is no more than 15.
- The total length of all cables used is no more than 2 meters times the number of devices connected together, up to a maximum of 20 meters. (Refer to table 2-2 for a list of HP-IB cables available from Hewlett-Packard.)

Do not stack more than three connector blocks together on any HP-IB connector. Make sure all connectors are fully seated and the lock screws are firmly finger-tightened.

RS-232 Interface

The dc source provides an RS-232 programming interface, which is activated by commands located under the front panel **Address** key. All SCPI and COMPAtibility commands are available through RS-232 programming. When the RS-232 interface is selected, the HP-IB interface is disabled.

The RS-232 connector is a DB-9, male connector. Adapters are available to connect the dc source to any computer or terminal with a properly configured DB-25 connector. (see Table 2-2)

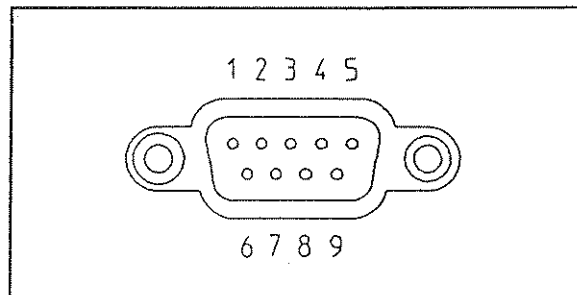

Figure 3-5. RS-232 Connector

Pin	Input/Output	Description
1	—	no connection
2	Input	Receive Data (RxD)
3	Output	Transmit Data (TxD)
4	—	reserved
5	Common	Signal ground
6	Input	reserved
7	Output	reserved
8	Input	reserved
9	—	no connection













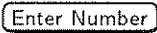



Turn-On Checkout

Introduction

Successful tests in this chapter provide a high degree of confidence that the dc source is operating properly. For verification tests, see appendix B. Complete performance tests are given in the Service Guide.

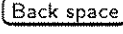
Note This chapter provides a preliminary introduction to the dc source front panel. See chapter 5 for more details.

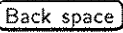
Using the Keypad

-  **Shift Key** Some of the front panel keys perform two functions, one labeled in black and the other in blue. You access the blue function by first pressing the blue  shift key. Release the key after you press it. The **Shift** annunciator will be on, indicating that you have access to any key's shifted function.
-  **Key** Used to access a third level key function – the numeric entry keys. These third level function keys are labeled in green.
-  and  **Keys** These keys let you scroll up and down through the choices in the presently selected function menu. All menu lists are circular; you can return to the starting position by continuously pressing either key.
-  and  **Keys** These keys let you select the previous or the next parameter for a specific command. If the command has a numeric range, these keys increment or decrement the existing value. In meter mode, these keys can be used to adjust the magnitude of the output voltage or current. Only the flashing digit is changed by these keys. Use the  and  keys to move the flashing digit.
-  and  **Keys** These **Entry** keys move the flashing digit in a numeric entry field to the right or left. This lets you increment or decrement a specific digit in the entry field using the  and  keys or the RPG knob.
-  **Key** The backspace key is an erase key. If you make a mistake entering a digit and have not yet pressed , you can delete the digit by pressing . Delete more digits by repeatedly pressing this key.
-  **Key** Executes the entered value or parameter of the presently accessed command. Until you press this key, the parameters you enter with the other keys are displayed but not entered into the dc source. After pressing , the dc source returns to Meter mode.

Checkout Procedure

The test in this section checks for output voltage and current on the dc source.

Note To perform the checkout procedure, you will need a wire for shorting the output terminals together.

The following procedure assumes that the unit turns on in the factory-default state. If you need more information about the factory default state, refer to the *RST command in chapter 4 of the Programming Guide. Note that the values shown in the Display column may not exactly match the values that appear on the front panel of your unit.

If you have not already done so, connect the power cord to the unit and plug it in.

Procedure	Display	Explanation
1. Turn the unit on. The dc source undergoes a self-test when you first turn it on.	***** ADDRESS 5 0.2410V 0.0006A	During selftest, all display segments are briefly lit, followed by the HP-IB Address. The display then goes into meter mode with the Dis annunciator on, and all others off. In Meter mode the *****V digits indicate the output voltage and the *****A digits indicate the output current. The <i>flashing</i> digit on the display indicates the digit that will be affected if changes are made to the displayed values using the rotary control or the <input type="button" value="↑"/> and <input type="button" value="↓"/> keys. You will only see the changes if the output is ON.

Note Press the key to exit a menu at any time and return to meter mode. If the **Err** annunciator on the display is on, press followed by to see the error number. Go to "In Case of Trouble" at the end of this chapter.

2. Check that the dc source fan is on		You should be able to hear the fan and feel the air coming from the back of the unit.
3. Press the <input type="button" value="Voltage"/> key, then <input type="button" value="Enter Number"/> , <input type="button" value="2"/> , <input type="button" value="0"/> , <input type="button" value="Enter"/>	VOLT 0.000 VOLT 20	Programs the output to 20 volts. After the value is entered, the display returns to Meter mode. Because the output has not been enabled, the meter still indicates approximately 0 volts.
4. Press <input type="button" value="Output on/off"/>	20.003V 0.0006A	Turns the output on. The Dis annunciator should be off and CV should be on.
5. Press <input type="button" value="Shift"/> and <input type="button" value="OV"/>	VOLT:PROT 22.00	Display shows the overvoltage protection trip voltage for your unit.

Procedure	Display	Explanation
6. Press <input type="text" value="Enter Number"/> , <input type="text" value="1"/> , <input type="text" value="5"/> , <input type="text" value="Enter"/>	VOLT:PROT 15 0.449V 0.145A	Programs the OVP to 15 volts, which is less than the previously set output voltage. Because the OVP voltage entered was less than the output voltage, the OVP circuit tripped. The output dropped to zero, CV turned off, and Prot turned on.
7. Press <input type="text" value="Shift"/> and <input type="text" value="OV"/> , then <input type="text" value="Enter Number"/> , <input type="text" value="2"/> , <input type="text" value="2"/> , <input type="text" value="Enter"/>	VOLT:PROT 22	Programs the OVP to a value greater than the output voltage setting of the unit. This prevents the OV circuit from tripping again when the protection condition is cleared.
8. Press <input type="text" value="Shift"/> , <input type="text" value="Prot Clear"/>	20.003V 0.0034A	Clears the protection condition, thus restoring the output of the unit. Prot turns off and CV turns on.
9. Press <input type="text" value="Output on/off"/>		Turn the output off.
10. Connect a jumper wire across the + and - output terminals.		Shorts the output of the unit.
11. Press <input type="text" value="Output on/off"/> .	0.0005V 0.2005A	The CC annunciator is on, indicating that the unit is in constant current mode. The unit is sourcing output current at 10% of the maximum rating (the default output current limit setting).
12. Press <input type="text" value="Current"/> , <input type="text" value="Enter Number"/> , <input type="text" value="1"/> , <input type="text" value="Enter"/> .	0.0452V 0.998A	Programs the output current to 1 ampere.
13. Press <input type="text" value="Shift"/> and <input type="text" value="OCP"/>	0.0005V 0.0003A	You enabled the overcurrent protection circuit. The circuit then tripped because the unit was operating in constant current mode. The CC annunciator turns off and the OCP and Prot annunciators come on.
14. Press <input type="text" value="Shift"/> and <input type="text" value="OCP"/>	0.0005V 0.0003A	You have disabled the overcurrent protection circuit. The OCP annunciator turns off.
15. Press <input type="text" value="Shift"/> and <input type="text" value="Prot Clear"/>	0.0452V 0.998A	Restores the output. The Prot annunciator turns off. CC is on.
16. Turn the unit off and remove the shorting wire from the output terminals.		The next time the unit turns on it will be restored to the *RST or factory default state.

In Case of Trouble

Error Messages

Dc source failure may occur during power-on selftest or during operation. In either case, the display may show an error message that indicates the reason for the failure.

Selftest Errors

Pressing **Shift** and **Error** will show the error number. Selftest error messages appear as: ERROR <n> where “n” is a number listed in the following table. If this occurs, turn the power off and then back on to see if the error persists. If the error message persists, the dc source requires service.

Table 4-1. Power-On Selftest Errors

Error No.	Failed Test
Error 0	No error
Error 1	Non-volatile RAM RD0 section checksum failed
Error 2	Non-volatile RAM CONFIG section checksum failed
Error 3	Non-volatile RAM CAL section checksum failed
Error 4	Non-volatile RAM STATE section checksum failed
Error 5	Non-volatile RST section checksum failed
Error 10	RAM selftest
Error 11 to 14	VDAC/IDAC selftest 1 to 4
Error 15	OVDAC selftest
Error 80	Digital I/O selftest error

Runtime Error Messages

Appendix C lists other error messages that may appear at runtime. If the front panel display shows OVLVD , this indicates that the output voltage or current is beyond the range of the meter readback circuit.

Line Fuse

If the dc source appears “dead” with a blank display and the fan not running, check your power source to be certain line voltage is being supplied to the dc source. If the power source is normal, the dc source fuse may be defective.

1. Turn off the front panel power switch and unplug the power cord.
2. Remove the fuse from the rear panel.
3. If the fuse is defective, replace it with a fuse of the same type (see “Input Connections” in chapter 3).
4. Turn on the dc source and check the operation.

Note If the dc source has a defective fuse, replace it only once. If it fails again, the dc source requires service.

Front Panel Operation

Introduction

Here is what you will find in this chapter:

- a complete description of the front panel controls
- front panel programming examples

Note The dc source must be in set to Local mode to use the front panel controls. Press the **Local** key on the front panel to put the unit in local mode.

Front Panel Description

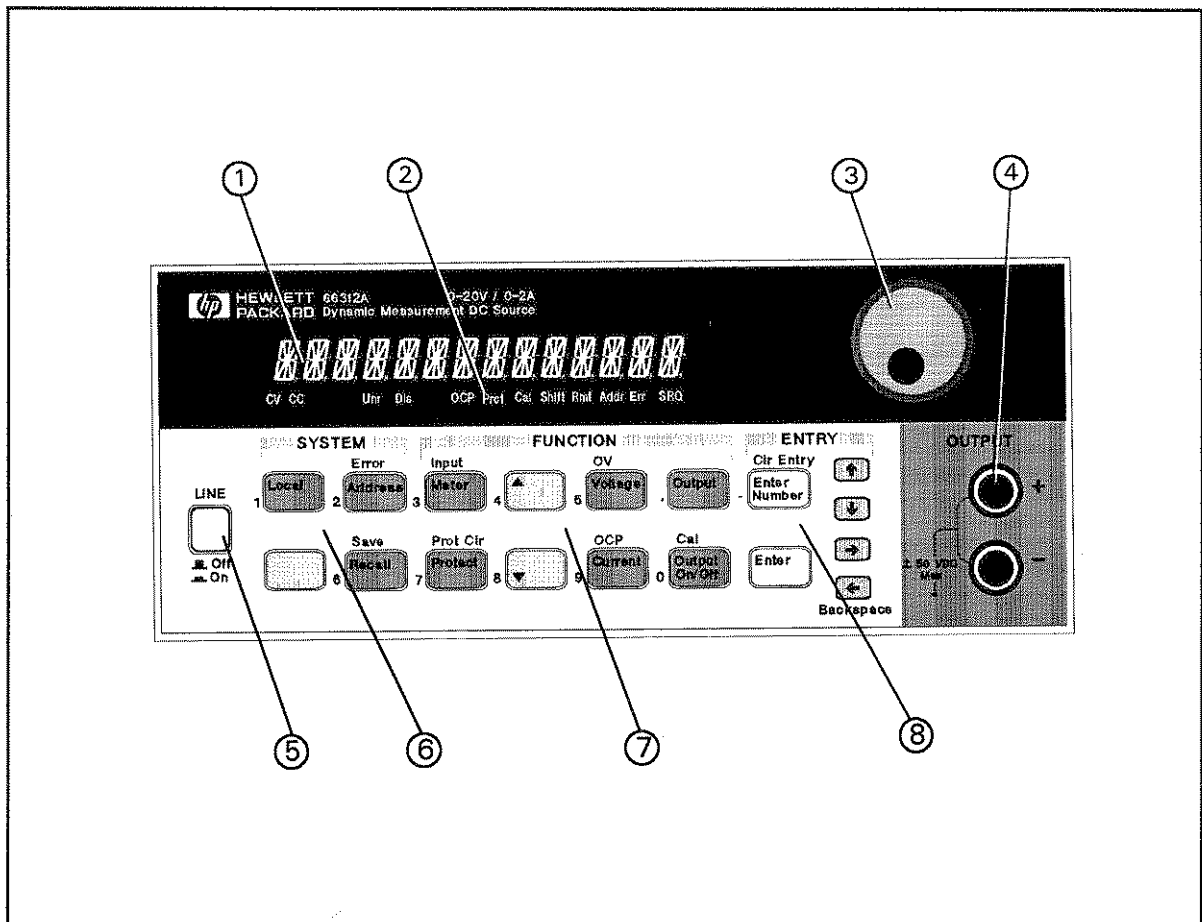







Figure 5-1. Front Panel, Overall View

- ① **Display** 14-character vacuum fluorescent display for showing output measurements and programmed values.
- ② **Annunciators** Annunciators light to indicate operating modes and status conditions:
- CV** The dc source output is in constant-voltage mode.
 - CC** The dc source output is in constant-current mode.
 - Unr** The dc source output is in an unregulated state.
 - Dis** The dc source output is disabled (off).
 - OCP** The overcurrent protection state is enabled.
 - Prot** One of the dc source's output protection features is activated.
 - Cal** The dc source is in calibration mode.
 - Shift** The Shift key is pressed to access an alternate key function.
 - Rmt** The selected interface (HP-IB or RS-232) is in a remote state.
 - Addr** The interface is addressed to talk or to listen.
 - Err** There is a message in the SCPI error queue.
 - SRQ** The interface is requesting service from the controller.
- ③ **Rotary Control** The rotary control lets you set the output voltage or current as well as menu parameters. Press  and  to select the resolution, then adjust the value with the knob.
- ④ **Output Connectors** Front panel binding posts let you connect loads to the front of the unit. Before using the front panel binding posts, make sure that the sense switch on the back of the unit is set to Local.
- ⑤ **Line** This turns the dc source on or off.
- ⑥ **System Keys** The system keys let you:
- Return to Local mode (front panel control)
 - Set the dc source HP-IB address
 - Set the RS-232 interface communication baud rate and parity bit
 - Display SCPI error codes and clear the error queue
 - Save and recall up to 4 instrument operating configurations
- ⑦ **Function Keys** Function access command menus that let you:
- Enable or disable the output
 - Select metering functions
 - Program output voltage and current
 - Display the protection status state
 - Set and clear protection functions
 - Set the output state at power-on
 - Calibrate the dc source
 -  and  scroll through the front panel menu commands
- ⑧ **Entry Keys** Entry keys let you:
- Enter programming values
 - Increment or decrement programming values
 -  and  select the front panel menu parameters

System Keys

Refer to the examples later in this chapter for more details on the use of these keys.

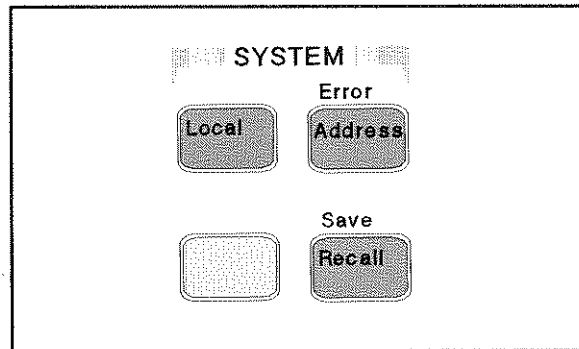

Figure 5-2. System Keys



This is the blue, unlabeled key, which is also shown as **Shift** in this guide. Pressing this key accesses the alternate or shifted function of a key (such as **Error**). Release the key after you press it. The **Shift** annunciator is lit indicating that the shifted keys are active.



Press to change the dc source's selected interface from remote operation to local (front panel) operation. Pressing the key will have no effect if the interface state is already Local, Local-with-Lockout, or Remote-with-Lockout.

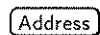

Press to access the system address menu. This menu lets you configure the dc source's interface. *Address Menu entries are stored in non-volatile memory.*

Display	Command Function
ADDRESS <value>	Set HP-IB address
INTF <char>	Select interface (HPIB or RS232)
BAUDRATE <char>	Baud rate (300 600 1200 2400 4800 9600)
PARITY <char>	Message parity (NONE EVEN ODD MARK SPACE)
FLOW <char>	Flow control (XON-XOFF NONE)
LANG <char>	Select language (SCPI or COMP)

value = a numeric value

char = a character string parameter

Use and to scroll through the command list.

Use and to scroll through the parameter list.



Press to place the dc source into a previously stored state. You can recall up to 4 (0 through 3) previously stored states.



Press to display the system error codes stored in the SCPI error queue. This action also clears the queue. If there is no error in the queue, 0 is displayed.



Press to store an existing dc source state in non-volatile memory. The parameters saved are listed under *SAV in the dc source Programming Guide. You can save up to 4 states (0 through 3).

Function Keys

Refer to the examples later in this chapter for more details on the use of these keys.

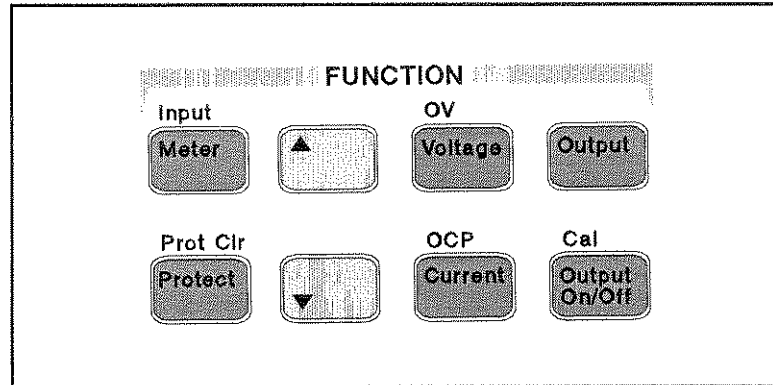

Figure 5-3. Function Keys

Immediate Action Keys

Immediate action keys **immediately** execute their corresponding function when pressed. Other function keys have commands underneath them that are accessed when the key is pressed.

Output On/Off This key toggles the output of the dc source between the **on** and **off** states. It immediately executes its function as soon as you press it. When off, the dc source output is disabled and the **Dis** annunciator is on.

Shift Prot Clear Press this key to reset the protection circuit and allow the unit to return to its last programmed state. The condition that caused the protection circuit to become active must be removed prior to pressing this key, or the unit will shut down again and display the **Prot** annunciator again. (If **FS** protection is displayed on the front panel, the unit must be opened and an internal fuse replaced as described in the Service manual.)

Shift OCP Press this key to toggle between OCP enabled and disabled. If OCP is enabled the output will become disabled if the output mode changes from **CV** to **CC** mode. The OCP annunciator indicates the state of OCP.

Scrolling Keys

Scrolling keys let you move through the commands in the presently selected function menu.

▲ ▼ Press **▼** to bring up the next command in the list. Press **▲** to go back to the previous command in the list. Function menus are circular; you can return to the starting position by continuously pressing either key. The following example shows the commands in the **Input** function menu:

▼ CURR:RANGE <char>
▼ CURR:DET <char>

Metering Keys

Metering keys control the metering functions of the dc source. When the unit is operating in front panel meter mode, all front panel measurements are calculated from a total of 2048 readings taken at a 46.8 microsecond sampling rate. Therefore, the total acquisition time for a single front panel measurement is about 100 milliseconds.

Note You can vary the both the sampling rate and the number of data points in each measurement when controlling the unit over the HP-IB interface. (Refer to chapter 3 in the Programming Guide).

Meter

Press this key to access the meter menu list. Also use this key to exit a menu at any time and return to meter mode.

Display	Measurement
<reading>V <reading>A	measures dc voltage and current
<reading>V MAX	measures peak voltage ¹
<reading>V MIN	measures minimum voltage ¹
<reading>V HIGH	measures high level of a voltage pulse waveform ¹
<reading>V LOW	measures low level of a voltage pulse waveform ¹
<reading>V RMS	measures rms voltage ¹
<reading>A MAX	measures peak current ¹
<reading>A MIN	measures minimum current ¹
<reading>A HIGH	measures high level of a current pulse waveform ¹
<reading>A LOW	measures low level of a current pulse waveform ¹
<reading>A RMS	measures rms current ¹

Shift **Input**

Press this key to access the following metering functions.

Display	Command Function
CURR:RANGE <char>	Select current range (AUTO, LOW or HIGH)
CURR:DET <char>	Select current measurement bandwidth (ACDC or DC) ¹



Notes:



¹These functions only available on HP Model 66312A



reading = the returned measurement

value = a numeric value

char = a character string parameter

 and  scroll through the menu commands.

 and  scroll through the menu parameters.

 and  select a digit in a numeric entry field.

Examples of Front Panel Programming

You will find these examples on the following pages:

- 1 - Setting the output voltage and current
- 2 - Querying and clearing output protection
- 3 - Making front panel measurements
- 4 - Programming the digital port
- 5 - Setting the HP-IB address or RS-232 parameters
- 6 - Saving and recalling operating states

The examples in the dc source Programming Guide are similar to the ones in this section, except that they use the SCPI commands.

1 - Setting the Output Voltage and Current

Action	Display
Set the output voltage	
1. To enter an approximate value without using the voltage menu: On the Entry keypad, press <input type="button" value="←"/> or <input type="button" value="→"/> to select the 1's digit in the voltage field. Then rotate the front panel RPG knob to obtain 12 V. <i>If the unit is in CC mode, you won't see the output voltage change until the voltage setting is low enough to cause the unit to go into CV mode.</i>	12.003V 0.004A
2. The easiest way to enter an accurate value: On the Function keypad, press <input type="button" value="Voltage"/> . On the Entry keypad, press <input type="button" value="Enter Number"/> <input type="button" value="1"/> <input type="button" value="2"/> <input type="button" value="Enter"/> .	VOLT 12.000
3. To make minor changes to an existing value: On the Function keypad, press <input type="button" value="Voltage"/> . On the Entry keypad, press <input type="button" value="←"/> or <input type="button" value="→"/> to select the digit in the numeric field that you wish to change. For example, move the flashing digit to the ones column to change a value in this column. Then, press <input type="button" value="↑"/> to scroll from 12.000 to 13.000. Then press <input type="button" value="Enter"/> .	VOLT 13.000
Set the output current	
1. To enter an approximate value without using the current menu: On the Entry keypad, press <input type="button" value="←"/> or <input type="button" value="→"/> to select the tenths digit in the current field. Rotate the front panel RPG knob to obtain 1.2 A. <i>If the unit is in CV mode, you won't see the output current change until the current setting is low enough to cause the unit to go into CC mode.</i>	12.003V 1.200A
2. The easiest way to enter an accurate value: On the Function keypad, press <input type="button" value="Current"/> . On the Entry keypad, press <input type="button" value="Enter Number"/> <input type="button" value="1"/> <input type="button" value="."/> <input type="button" value="2"/> <input type="button" value="Enter"/> .	CURR 1.200
3. To make minor changes to an existing value. On the Function keypad, press <input type="button" value="Current"/> . On the Entry keypad, press <input type="button" value="←"/> or <input type="button" value="→"/> to select the digit in the numeric field that you wish to change. For example, move the flashing digit to the tenths column to change a value in this column. Then, press <input type="button" value="↑"/> to scroll from 1.200 to 1.500. Then press <input type="button" value="Enter"/> .	CURR 1.500
Enable the output	
1. On the Function keypad, press <input type="button" value="Output On/Off"/> to enable the output. The Dis annunciator will go off, indicating that the voltage is now applied to the output terminals. The A display indicates the actual output current.	12.003V 1.200A

2 - Querying and Clearing Output Protection

The dc source will disable its output if it detects an overvoltage or overcurrent fault condition. Other automatic fault conditions (such as overtemperature) also will disable the output.

Query and clear the dc source overcurrent protection feature as follows:

Action	Display
1. On the Function keypad, press Protect . In this example, OC indicates that an overcurrent condition has occurred. Other protection indicators are: OT (overtemperature), OV (overvoltage), RI (remote inhibit), and FS (internal fuse is open).	OC -- -- -- --
2. On the Function keypad, press Current . This displays the present output current limit. (10% of the maximum rating is the default output current limit setting).	CURR 0.2045
3. To restore normal operation after the cause of the overcurrent condition has been removed, press Shift Prot Clr . The OCP annunciator then will go off.	

3 - Making Front Panel Measurements

When the dc source is operating in front panel meter mode, all front panel measurements are calculated from a total of 2048 readings taken at a 46.8 microsecond sampling rate. These parameters are fixed. Therefore, the data acquisition time for a single front panel measurement is about 100 milliseconds. All front panel measurements are continuously updated at this rate.

Note You can vary the both the sampling rate and the number of data points in each measurement when controlling the unit over the HP-IB interface. When making pulse measurements, the HP-IB interface also lets you qualify the triggers that initiate the measurements. Refer to chapter 3 in the Programming Guide for more information.

Two current measurement ranges can be selected. A high current range is available for measuring output currents up to the 20% higher than the maximum rating of the dc source. A low current range is available for improved resolution when measuring output currents below 20 milliamperes. The low current measurement range is accurate to 0.1% of the reading ± 2.5 microamperes.

The HP 66312A dc source has the additional capability of measuring output waveform parameters such peak, minimum, high level, and low level as shown in the following figure.

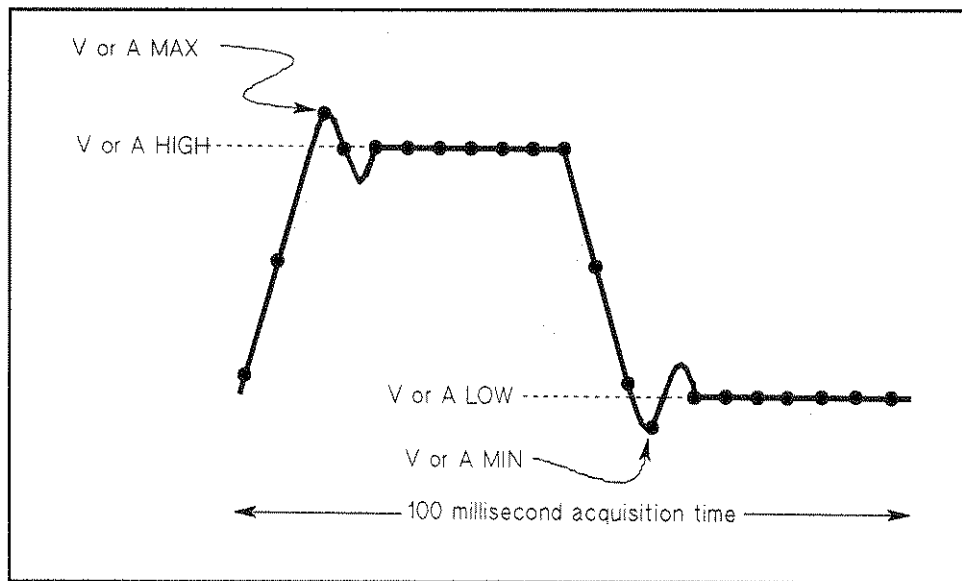

Figure 5-5. Front Panel Pulse Measurement Parameters (HP 66312A only)

Use the Meter menu for making front panel measurements:

- | Action | Display |
|--|--|
| 1. For current measurements, press Shift Input . Then press □ until you obtain the CURR:RANG AUTO command. Press Enter to activate autoranging. Two other selections are also available. Select the High range when measuring currents above 20 mA. Select the Low range for improved resolution when measuring currents below 20 mA. | CURR:RANG AUTO |
| 2. For output waveform measurements, press Shift Input . Then press ▼ until you obtain the CURR:DET ACDC command. Check to make sure that the ACDC current detector is selected. Only select the DC current detector if you are making dc current measurements and you require a dc measurement offset better than 1mA on the High current measurement range.
Note that in the Low current measurement range, the current detector is fixed at DC. Accurate current measurements cannot be made on waveforms with frequency contents over a few kHz. | CURR:DET ACDC |
| 3. On the Function keypad press Meter and press ▼ repeatedly to access the following measurement parameters: | |
| <ul style="list-style-type: none"> • dc voltage and current • maximum peak voltage¹ • minimum voltage¹ • high level of a voltage pulse waveform¹ • low level of a voltage pulse waveform¹ • rms voltage¹ • maximum peak current¹ • minimum current¹ • high level of a current pulse waveform¹ • low level of a current pulse waveform¹ • rms current¹ | <pre> <reading>V <reading>A <reading>V MAX <reading>V MIN <reading>V HIGH <reading>V LOW <reading>V RMS <reading>A MAX <reading>A MIN <reading>A HIGH <reading>A LOW <reading>A RMS </pre> |

¹HP 66312A only

4 - Programming the Digital Output Port

Your dc source is shipped with the output port function set to RIDFI mode. In this mode the port functions as a remote inhibit input with a discrete fault indicator output signal. You can also configure the port to act as a Digital Input/Output device.

To configure the RIDFI mode of the port, proceed as follows:

Action	Display
1. On the Function keypad, press Output .	*RST
2. Scroll through the Output menu by pressing ▼ . The PORT command lets you select either the RIDFI or the DIGIO function.	PORT RIDFI
3. Scroll to the RI command to configure the Remote Inhibit indicator. Use the ↑ and ↓ keys to select either LIVE or LATCHING, either of which enable the RI indicator. With RI enabled, a low-true on the INH input will disable the output of the unit. LIVE causes the output of the unit to track the state of the INHibit input. LATCHING latches the output of the unit off in response to the INHibit signal.	RI LIVE RI LATCHING
4. Access the Output menu again and scroll through the menu. The DFI command lets you enable the Discrete Fault Indicator. Use the ↓ key and select ON to enable the FLT output. With the FLT output enabled, the open-collector logic signal can be used to signal external devices when a fault condition is detected.	DFI ON
5. Scroll to the DFI:SOUR command to select the internal source that drives this signal. Use the ↓ key to select from the RQS or ESB bits, or the Operation or Questionable status registers. Status summary bits are explained in chapter 3 of the Programming Guide.	DFI:SOUR RQS DFI:SOUR ESB DFI:SOUR OPER DFI:SOUR QUES

To configure the DIGIO mode of the port, proceed as follows:

Action	Display
1. On the Function keypad, press Output .	*RST
2. Scroll through the Output menu by pressing ▼ . The PORT command lets you select either the RIDFI or the DIGIO function.	PORT DIGIO
3. Scroll to the DIGIO command to set and read the Digital Input/Output Port. Press Enter Number and enter a number from 0 to 7 to program the four bits (0 programs all bits low; 7 programs all bits high). Press Enter when done.	DIGIO 5

5 - Setting the HP-IB Address and RS-232 Parameters

Your dc source is shipped with the HP-IB address set to 5. This address can only be changed from the front panel using the Address menu located under the **Address** key. This menu is also used to select the RS-232 interface and specify RS-232 parameters such as baud rate and parity.

Action	Display
Set the HP-IB address as follows:	
1. On the System keypad, press Address .	ADDRESS 5
2. Enter the new address. For example, Press Enter Number , 7 , Enter .	ADDRESS 7
Configure the RS-232 interface as follows:	
1. On the System keypad, press Address .	ADDRESS 5
2. Scroll through the Address menu by pressing ▼ . The interface command lets you select the RS-232 interface. The baudrate command lets you select the baudrate. The parity command lets you select the parity. The flow command selects the flow control options.	INTF RS232 BAUDRATE 9600 PARITY EVEN XON-XOFF
3. The ↑ and ↓ keys let you select the command parameters.	

6 - Saving and Recalling Operating States

You can save up to 4 states (from location 0 to location 3) in non-volatile memory and recall them from the front panel. All programmable settings are saved.

Action	Display
Save an operating state in location 1 as follows:	
1. Set the instrument to the operating state that you want to save.	
2. Save this state to location 1. Press Save , Enter Number , 1 , Enter .	*SAV 1
Recall a saved state as follows:	
1. Recall the state saved in location 1 by pressing Recall , Enter Number , 1 , and Enter .	*RCL 1
Select the power-on state of the dc source as follows:	
1. On the Function keypad, press Output , and scroll through the Output menu until you get to the PON state command.	PON:STATE RST
2. Use the ↑ and ↓ keys to select either RST or RCL0. RST sets the power-on state of the unit as defined by the *RST command. RCL0 sets the power-on state of the unit to the state saved in *RCL location 0.	

Specifications

Specifications

Table A-1 lists the specifications of the dc source. Specifications are warranted over the ambient temperature range of 0 to 55 °C. Unless otherwise noted, specifications apply after a 30-minute warmup period.

Table A-1. Performance Specifications

Parameter		HP 66312A and HP 6612B
Output Ratings	Voltage:	0–20 V
	Current:	0–2
Programming Accuracy (@ 25°C ±5°C)	Voltage:	0.05% + 10 mV
	+Current:	0.05% + 1 mA
DC Measurement Accuracy (via HP-IB or front panel meters with respect to actual output at 25°C ±5°C)	Voltage:	0.03% + 3 mV
	Low Current range –20 mA to +20 mA:	0.1% + 2.5 μ A ¹
	High Current range +20 mA to +rated I:	0.2% + 0.25 mA ²
	–20 mA to –rated I:	0.2% + 0.85 mA
Ripple and Noise (in the range of 20 Hz to 20 MHz with outputs ungrounded or with either terminal grounded)	Voltage (rms/p-p):	0.5 mV/3 mV
	Current (rms):	1 mA
Load Regulation ³ (change in output voltage or current for any load change within ratings)	Voltage:	2 mV
	Current:	0.5 mA
Line Regulation (change in output voltage or current for any line change within ratings)	Voltage:	0.5 mV
	Current:	0.5 mA
Transient Response Time (for the output voltage to recover to its previous level within 0.1% of the voltage rating of the unit following a change in load current of up to 50% of the output current rating)		< 100 μ s

1 This specification may degrade slightly when the unit is subjected to an RF field ≥ 3 V/meter.

2 Applies with current detector set to DC. With current detector set to ACDC, accuracy is 0.2% + 1 mA

3 Applies at rear terminals with unit set to remote sensing and with sense terminals externally jumpered to their respective output terminals.

Supplemental Characteristics

Table A-2 lists the supplemental characteristics, which are not warranted but are descriptions of typical performance determined either by design or type testing.

Table A-2. Supplemental Characteristics

Parameter		HP 66312A	HP 6612B
Input Ratings (at full load)	100 Vac mains:	87–106 Vac, 47–63 Hz, 1.6 A, 100 W	
	115 Vac mains:	104–127 Vac, 47–63 Hz, 1.4 A, 100 W	
	220 Vac mains:	191–233 Vac, 47–63 Hz, 0.8 A, 100 W	
	230 Vac mains:	207–253 Vac, 47–63 Hz, 0.75 A, 100 W	
Output Programming Range	Voltage:	0–20.475 V	
	Current:	0–2.0475 A	
	OVP:	0–22 V	
Average Programming Resolution	Voltage:	5 mV	
	Current:	0.5 mA	
	OVP:	100 mV	
OVP Accuracy		2.4% + 240 mV	
Maximum Current Measurement		2.43 A	
Average Current Measurement Resolution	High Range:	74 μ A	
	Low Range:	0.6 μ A	
Sink Current ¹		–1 A	
Programming Accuracy Temp. Coefficient (change/°C)	Voltage:	0.01% + 0.25 mV	
	Current:	0.01% + 12 μ A	
	OVP:	0.015% + 4 mV	
Readback Accuracy Temp. Coefficient (change/°C)	Voltage:	0.01% + 150 μ V	
	Current (ACDC):	0.05% + 80 μ A	
	Current (DC):	0.02% + 10 μ A	
	Current (Low range):	0.01% + 0.3 μ A	
Drift ²	Voltage:	0.01% + 0.5 mV	
	Current:	0.01% + 20 μ A	
Output Voltage Rise/Fall Time		2 ms (for a change from 10% to 90% or 90% to 10% of the total excursion)	
Output Voltage Settling Time		6 ms (to settle within 1 LSB or 0.025% times the rated voltage of the final value)	

1 The sink current does not track the programmed current.

2 Following a 30 minute warmup, the change in output over 8 hours, under ambient temperature, constant load, and line operating conditions.

Table A-2. Supplemental Characteristics (continued)

Parameter		HP 66312A	HP 6612B
Dynamic Measurement Accuracy	Instantaneous Voltage: Instantaneous Current:	0.03% + 5 mV 0.6% + 1 mA ¹	not applicable
Dynamic Measurement System	Buffer Length: Sampling Rate Range:	4096 points 15.6–390 μ s	not applicable
Measurement Time (voltage or current)		50 ms average (includes the default time of 30 ms ² for acquiring data, and a 20 ms data processing overhead)	
Command Processing Time		4 ms average (for output to begin to change following receipt of data)	
Remote Sense Capability		Up to 2 volts can be dropped across each load lead. (add 2 mV to the voltage load regulation specification for each 1 V change in the positive output lead due to load current change.)	
Savable Instrument States		4 (in locations 0 to 3)	
RS-232 Interface Capabilities	Baud rates: Data formats: Language:	300 600 1200 2400 4800 9600 7 bits even or odd parity; 8 bits without parity SCPI or COMPATibility ³	
HP-IB Interface Capabilities	Language: Interface:	SCPI or COMPATibility ³ AH1, C0, DC1, DT1, E1, L4, PP0, RL1, SH1, SR1, T6	
INH/FLT Characteristics	Maximum ratings: INH Terminals: FLT Terminals:	16.5 Vdc between terminals 1 and 2; 3 and 4; and from terminals 1 or 2 to chassis ground Low-level output current = 1.25 mA max. Low-level output voltage = 0.5 V max. Low-level input voltage = 0.8 V max. High-level input voltage = 2 V min. Low-level input current = 1 mA Pulse width = 100 μ s min. Time delay = 4 ms typical	
Digital I/O Characteristics	Maximum ratings: Digital OUT Port 0,1,2 (open collector)	same as INH/FLT Characteristics Output leakage @ 16V = 0.1 mA (ports 0,1) = 12.5 mA (port 2) Output leakage @ 5V = 0.1 mA (ports 0,1) = 0.25 mA (port 2)	

1 For full scale current changes with a risetime of 20 μ s, an additional 0.5% error exists in the first data point in the buffer after the change. The error percentage increases proportionally with the decrease in risetime.

2 This time may be reduced by changing the default conditions of 2048 data points, however, measurement accuracy will be reduced.

3 Compatibility language is used to program the HP 663xA Series power supplies.

Table A-2. Supplemental Characteristics (continued)

Parameter		HP 66312A	HP 6612B
Digital I/O Characteristics (continued)	Digital IN Port 2: (internal pullup)	Low-level output sink current @ 0.5 V = 4 mA Low-level output sink current @ 1 V = 50 mA Low-level input current @ 0.4 V = 1.25 mA High-level input current @ 5 V = 0.25 mA Low-level input voltage = 0.8 V max. High level input voltage = 2.0 V min.	
Isolation to Ground		50 Vdc maximum from chassis ground	
Recommended Calibration Interval		1 year (from the date the unit is put into service)	
Regulatory Compliance	Listing pending: Certified to: Conforms to: Complies with:	UL 3111-1 CSA 22.2 No. 1010.1 IEC 1010-1 EMC directive 89/336/EEC (ISM Group1 Class B)	
Dimensions (see figure 3-1)		Height 88.1mm (3.5in.) Width 212.8mm (8.4in.) Depth 444.4mm (17.5in.)	
Net weight		8.85 kg (19.5 lbs.)	
Shipping weight		11.1 kg (24.5 lbs.)	

Verification & Calibration

Introduction

This appendix includes verification and calibration procedures for the HP 66312A and HP 6612B dc source. Instructions are given for performing the procedures either from the front panel or from a controller over the HP-IB.

The verification procedures do not check all the operating parameters, but verify that the dc source is performing properly. Performance Tests, which check all the specifications of the dc source, are given in the applicable dc source Service Manual.

Important Perform the verification procedures before calibrating your dc source. If the dc source passes the verification procedures, the unit is operating within its calibration limits and does not need to be recalibrated.

Equipment Required

The equipment listed in the following table, or the equivalent to this equipment, is required for verification and calibration.

Table B-1. Equipment Required

Equipment	Characteristics	Recommended Model
Digital Voltmeter	Resolution: 10 nV @ 1 V Readout: 8.5 digits Accuracy: >20 ppm	HP 3458A
Current Monitor ¹	15 A (0.1 Ω), ±0.04%, TC=5ppm/°C	Guildline 9230/15
Load Resistor	1.1 kΩ, 3 W min. TC=20ppm/°C	HP p/n 0811-2878
Power Supply	20 V @ 5 A	HP 6643A or HP 6653A
HP-IB Controller	Full HP-IB capabilities	HP Series 200/300 or equivalent

¹ The 4-terminal current shunt is used to eliminate output current measurement error caused by voltage drops in the load leads and connections. It has special current-monitoring terminals inside the load connection terminals. Connect the voltmeter directly to these current-monitoring terminals.

Test Setup

Figure B-1 shows the setup for the tests. Be certain to use load leads of sufficient wire gauge to carry the full output current (see chapter 3).

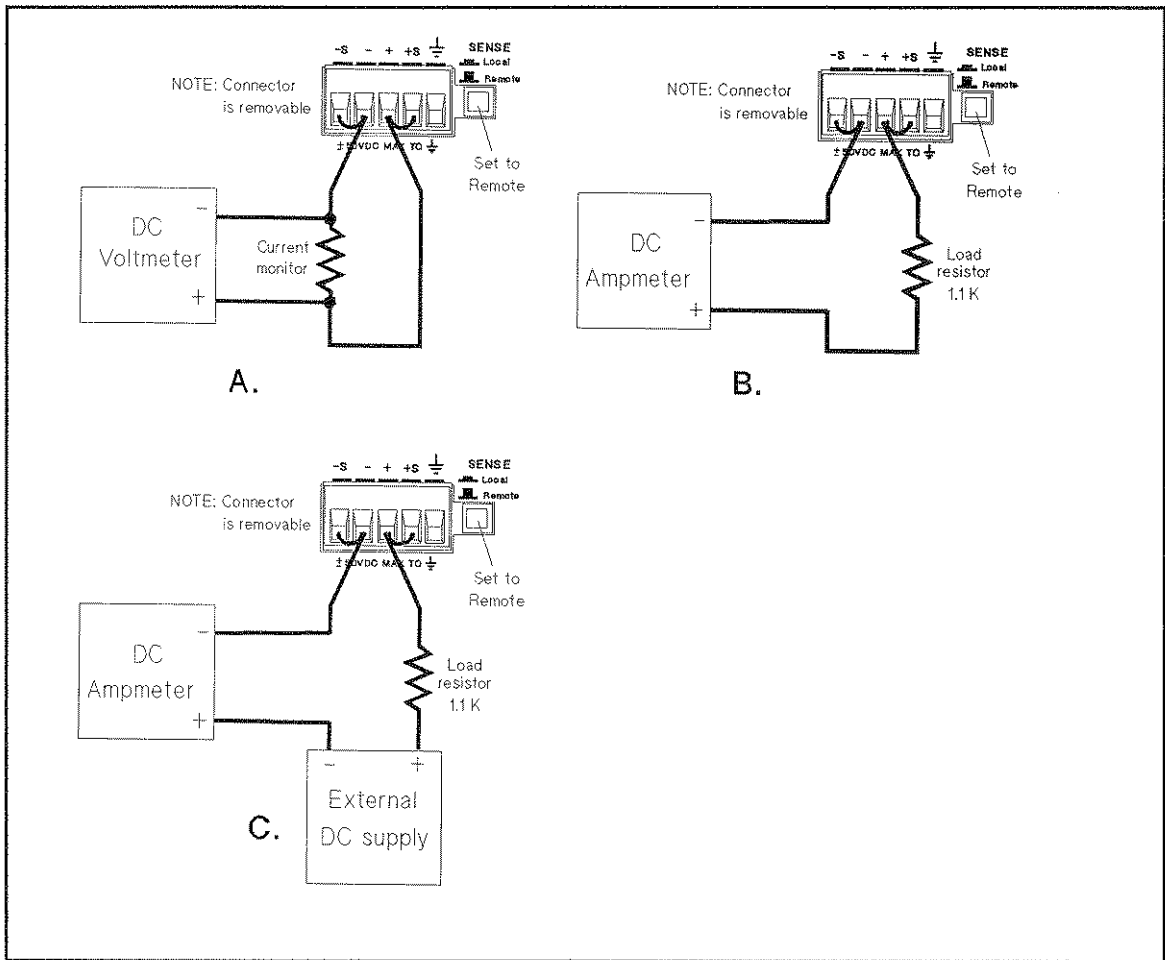

Figure B-1. Verification & Calibration Test Setup.

Performing the Verification Tests

Note The verification procedure can only be performed using the SCPI language commands. Use the `SYSTEM:LANGUage` command change the programming language to SCPI.

The following procedures assume you understand how to operate the dc source from the front panel as explained in chapter 5.

When performing the verification tests from an HP-IB controller, you may have to consider the relatively slow settling times and slew rates of the dc source as compared to computer and system voltmeters. Suitable `WAIT` statements can be inserted into the test program to give the dc source time to respond to the test commands.

Perform the following tests for operation verification in the order indicated.

1. Turn-On Checkout
2. Voltage Programming and Measurement Accuracy
3. Current Programming and Measurement Accuracy

Turn-On Checkout

Perform the Turn-On Checkout as directed in chapter 4.

Note The dc source must pass turn-on selftest before you can proceed with the verification tests.

Voltage Programming and Measurement Accuracy

This test verifies the voltage programming, HP-IB measurement, and front panel meter functions. Values read back over the HP-IB should be the same as those displayed on the front panel. Measure the dc output voltage at the output terminals. Make sure the sense switch is set to remote and the sense terminals are directly jumpered to the output terminals.

Action	Normal Result
1. Turn off the dc source and connect a DMM to the output terminals.	
2. Turn on the dc source with no load on the output. Set the output voltage to 0 V and the output current to 2 A. Press Output ON to enable the output.	Output voltage near 0 V. Output current near 0 A.
3. Record voltage readings at the DMM and on the front panel display.	Readings within low voltage limits (see table B-2).
4. Set the output voltage to 20 V.	Output voltage near 20 V.
5. Record voltage readings at the DMM and on the front panel display.	Readings within high voltage limits (see table B-2).

Current Programming and Measurement Accuracy

This test verifies the current programming and measurement. Connect the appropriate current monitor (see table B-1) as shown in figure B-1A.

Action	Normal Result
Current Programming and Measurement (High Range)	
1. Turn off the dc source and connect the DMM and current monitor as shown in figure B-1A.	
2. Turn on the dc source, access the Input menu, and set the current sense detector to DC.	CURR:DET DC
3. Set the output voltage to 5 V and the current to 0 A. Press Output ON to enable the output.	Output current near 0 A.
4. Divide the voltage drop across the current monitor by its resistance to convert the value to amperes. Record the value.	Readings within low current limits (see table B-2).
5. Set the output current to 2 A.	
6. Divide the voltage drop across the current monitor by its resistance to convert the value to amperes. Record this value as well as the current reading on the front panel display.	Readings within high current limits (see table B-2).

Action

Current Measurement (Low Range)
7. Turn off the dc source and connect a 1.1 kΩ resistor. Set the DMM to operate in current mode and connect it as shown in figure B-1B.

8. Turn on the dc source, access the Input menu, and set the current range to LOW.

9. Set the output voltage to 0 V and the current to 2 A. Press **Output ON** to enable the output.

10. Record the current reading from the DMM as well as from the front panel display. Enter the difference between the two readings in table B-2.

11. Set the output voltage to 20 V.

12. Record the current reading from the DMM as well as from the front panel display. Enter the difference between the two readings in table B-2.

Current Sink Measurement

13. Turn off the dc source and connect an external supply to the output of the unit as shown in figure B-1C. Set the DMM to operate in current mode and connect it as shown in the figure.

14. Turn on the dc source, access the Input menu, and set the current range to LOW.

15. Access the Input menu again, and set the current sense detector to DC.

16. Turn on the external supply and program the output for 20 V and 1.5 A. Program the dc source to 0 V and 1 A. Press **Output ON** to enable the output.

17. Record the current reading from the DMM as well as from the front panel display. Enter the difference between the two readings in table B-2.

18. Access the Input menu and set the current range to HIGH. Do not turn off the unit.

19. Short out the 1.1k resistor by connecting a jumper across it.

20. Record the current reading from the DMM as well as from the front panel display. Enter the difference between the two readings in table B-2.

CURR:RANG LOW

Output current near 0 A.

Readings within low current measurement (see table B-2).

Output current near +20 mA.

Readings within high current measurement (see table B-2).

CURR:RANG LOW

CURR:DET DC

Output current near -20 mA.

Readings within low current sink measurement (see table B-2).

CURR:RANG HIGH

Output current near -1 A

Readings within high current sink measurement (see table B-2).

Front Panel Calibration

These procedures assume you understand how to operate front panel keys (see chapter 5).

Enable Calibration Mode

Action	Display
1. Reset the unit by selecting Output , scrolling to *RST and pressing Enter .	*RST
2. Press Output ON to enable the output.	00.003V 0.0006A
3. To begin calibration press Shift Calibration , scroll to CAL ON and press Enter .	CAL ON 0.0
4. Enter the calibration password from Entry keypad and press Enter . If the password is correct the Cal annunciator will come on. If CAL DENIED appears, then an internal switch has been set to prevent the calibration from being changed. (See the <i>Service Manual</i>). If the password is incorrect, an error occurs. If the active password is lost, the calibration function can be recovered by setting an internal switch that defeats password protection. (See the <i>Service Manual</i>).	CAL DENIED OUT OF RANGE

Voltage Programming and Measurement Calibration

Action	Display
5. Connect the DMM (dc volts mode) directly to the dc source. Do not connect the load resistor or current shunt.	
6. Press Shift Calibration , scroll to CAL VOLT, and press Enter .	CAL:VOLT
7. Press Shift Calibration , scroll to CAL LEV, and press Enter to select the first calibration point.	CAL:LEV P1
8. Press Shift Calibration , scroll to CAL DATA, press Enter Number , and enter the voltage value displayed on the DMM.	CAL:DATA 0.00
9. Press Shift Calibration , scroll to CAL LEV, use ↓ to scroll to P2 (the second calibration point), and press Enter .	CAL:LEV P2
10. Press Shift Calibration , scroll to CAL DATA, press Enter Number , and enter the second voltage value displayed on the DMM.	CAL:DATA 0.00

Overvoltage Protection Calibration

Action	Display
11. Press Shift Calibration , scroll to CAL VOLT PROT, and press Enter .	CAL:VOLT:PROT
12. Wait for the dc source to compute the OVP calibration constant. The display returns to Meter mode when the calculation is complete.	

Current Programming and High-Range Measurement Calibration

Action	Display
13. Connect the appropriate current monitor as shown in figure B-1A. Connect the DMM (in dc mode) across the current shunt.	
14. Press Shift Calibration , scroll to CAL CURR, and press Enter .	CAL:CURR
15. Press Shift Calibration , scroll to CAL LEV, and press Enter to select the first calibration point.	CAL:LEV P1
16. Press Shift Calibration and scroll to CAL DATA. Wait for the DMM reading to stabilize. Then read the DMM and compute the first current value (DMM reading \div shunt resistance). Press Enter Number and enter the first current value.	CAL:DATA 0.00
17. Press Shift Calibration , scroll to CAL LEV, use ↓ to scroll to P2 (the second calibration point), and press Enter .	CAL:LEV P2
18. Press Shift Calibration and scroll to CAL DATA. Wait for the DMM reading to stabilize. Then read the DMM and compute the second current value (DMM reading \div shunt resistance). Press Enter Number and enter the second current value.	CAL:DATA 0.00

Low-Range Current Measurement Calibration

Action	Display
19. Connect the 1.1 K Ω load resistor as shown in figure B-1B. Connect the DMM (in current mode) in series with the load.	
20. Press Shift Calibration , scroll to CAL CURR MEAS LOW, and press Enter .	CAL:CURR:MEAS:LOW
21. Press Shift Calibration , scroll to CAL LEV, and press Enter to select the first calibration point.	CAL:LEV P1
22. Press Shift Calibration and scroll to CAL DATA. Wait for the DMM reading to stabilize. Then press Enter Number and enter the current reading displayed on the DMM.	CAL:DATA 0.00

AC Current Measurement Calibration (HP 66312A only)

Action	Display
23. Disconnect all loads from the dc source.	
24. Press Shift Calibration , scroll to CAL CURR MEAS AC, and press Enter .	CAL:CURR:MEAS AC
25. Wait for the dc source to compute the ac current calibration constant. The display returns to Meter mode when the calculation is complete.	

Saving the Calibration Constants

Caution Storing calibration constants overwrites the existing ones in non-volatile memory. If you are not sure you want to permanently store the new constants, omit this step. The dc source calibration will then remain unchanged.

Action	Display
25. Press Shift Calibration , scroll to CAL SAVE, and press Enter .	CAL:SAVE
26. Press Shift Calibration , select CAL OFF, and press Enter to exit Calibration mode. *RST and *RCL will also set the calibration state to OFF.	CAL OFF

Calibration Error Messages

Errors that can occur during calibration are shown in the following table.

Table B-3. HP-IB Calibration Error Messages

Error	Meaning	Error	Meaning
401	CAL switch prevents calibration ¹	406	Incorrect sequence of calibration commands
402	CAL password is incorrect	¹ This is a hardware disable. See the dc source <i>Service Manual</i> .	
403	CAL not enabled		
404	Computed readback cal constants are incorrect		
405	Computed programming cal constants are incorrect		

Changing the Calibration Password

The factory default password is 0. You can change the password when the dc source is in calibration mode (which requires you to enter the existing password). Proceed as follows:

Action	Display
1. Begin by pressing Shift Calibration and scrolling to the CAL ON command.	CAL ON 0.0
2. Enter the existing password from Entry keypad and press Enter .	
3. Press Shift Calibration and scroll to the CAL PASS command.	CAL:PASS 0
4. Enter the new password from the keypad. You can use any number with up to six digits and an optional decimal point. If you want the calibration function to operate without requiring any password, change the password to 0 (zero).	

Note If you want the calibration function to operate without requiring any password, change the password to 0 (zero).

Table C-1. Error Numbers (continued)

Error Number	Error String [Description/Explanation/Examples]
-141 -144 -148 -150 -151 -158 -160 -161 -168 -170 -171 -178	Invalid character data [bad character, or unrecognized] Character data too long Character data not allowed String data error Invalid string data [e.g., END received before close quote] String data not allowed Block data error Invalid block data [e.g., END received before length satisfied] Block data not allowed Expression error Invalid expression Expression data not allowed
-200 -222 -223 -224 -225 -270 -272 -273 -276 -277	Execution error [generic] Data out of range [e.g., too large for this device] Too much data [out of memory; block, string, or expression too long] Illegal parameter value [device-specific] Out of memory Macro error Macro execution error Illegal macro label Macro recursion error Macro redefinition not allowed
-310 -350 -400 -410 -420 -430 -440	System error Too many errors [errors beyond 9 lost due to queue overflow] Query error [generic] Query INTERRUPTED [query followed by DAB or GET before response complete] Query UNTERMINATED [addressed to talk, incomplete programming message received] Query DEADLOCKED [too many queries in command string] Query UNTERMINATED [after indefinite response]
0 1 2 3 4 5 10 11 12 13 14 15 80	No error Non-volatile RAM RD0 section checksum failed Non-volatile RAM CONFIG section checksum failed Non-volatile RAM CAL section checksum failed Non-volatile RAM STATE section checksum failed Non-volatile RST section checksum failed RAM selftest VDAC/IDAC selftest 1 VDAC/IDAC selftest 2 VDAC/IDAC selftest 3 VDAC/IDAC selftest 4 OVDAC selftest Digital I/O selftest error

Table C-1. Error Numbers (continued)

Error Number	Error String [Description/Explanation/Examples]
201	Front panel not responding
213	Ingrd receiver buffer overrun
216	RS-232 receiver framing error
217	RS-232 receiver parity error
218	RS-232 receiver overrun error
220	Front panel uart overrun
221	Front panel uart framing
222	Front panel uart parity
223	Front panel buffer overrun
224	Front panel timeout
401	CAL switch prevents calibration
402	CAL password is incorrect
403	CAL not enabled
404	Computed readback cal constants are incorrect
405	Computed programming cal constants are incorrect
406	Incorrect sequence of calibration commands
601	Too many sweep points
602	Command only applies to RS-232 interface
603	CURRent or VOLTage fetch incompatible with last acquisition
604	Measurement overrange

- Use a needlenose pliers and connect the ac input wiring harness according to the information in the following table:

Power Transformer AC Input Connections

Voltage	Wire	Connected to pin Number:
100 Vac	grey wire white/red/grey wire orange jumper #1 orange jumper #2	pin #5 pin #6 pin #1 and pin #4 pin #2 and pin #7
120 Vac	grey wire white/red/grey wire orange jumper #1 orange jumper #2	pin #4 pin #6 pin #1 and pin #3 pin #2 and pin #7
220 Vac	grey wire white/red/grey wire orange jumper #1 orange jumper #2	pin #1 pin #6 pin #3 and pin #5 not used
230 Vac	grey wire white/red/grey wire orange jumper #1 orange jumper #2	pin #1 pin #6 pin #2 and pin #4 not used

Install the Correct Line Fuse

- Unscrew the line fuse cap from the rear panel and install the correct fuse.
 For 100/120 Vac operation: 2 A; HP part number 2110-0002
 For 220/230 Vac operation: 1 A; HP part number 2110-0012
- Mark the voltage setting that the unit has been set to on the rear panel label.

Close the Unit

- Replace the outer cover.
- Reconnect the power cord and turn on the unit.